

Stepping Motors

Structure of Stepping Motors

The figures below show two cross-sections of a 0.72° stepping motor.

The stepping motor consists primarily of two parts: a stator and rotor.

The rotor is made up of three components: rotor 1, rotor 2 and a permanent magnet. The rotor is magnetized in the axial direction so that, for example, if rotor 1 is polarized north, rotor 2 will be polarized south.

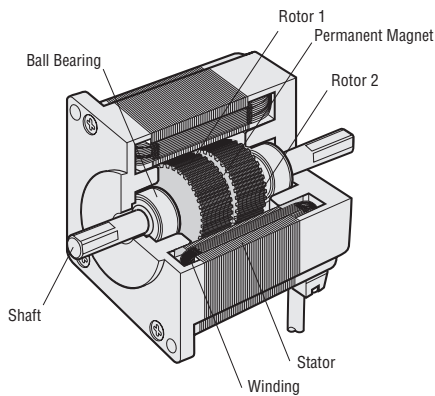

Motor Structural Diagram: Cross-Section Parallel to Shaft

The stator has ten magnetic poles with small teeth, each pole being provided with a winding.

Each winding is connected to the winding of the opposite pole so that both poles are magnetized in the same polarity when current is sent through the pair of windings. (Running a current through a given winding magnetizes the opposing pair of poles in the same polarity, i.e., north or south.)

The opposing pair of poles constitutes one phase. Since there are five phases, A through E, the motor is called a "0.72° stepping motor."

There are 50 small teeth on the outer perimeter of each rotor, with the small teeth of rotor 1 and rotor 2 being mechanically offset from each other by half a tooth pitch.

Excitation: To send current through a motor winding

Magnetic pole: A projected part of the stator, magnetized by excitation

Small teeth: The teeth on the rotor and stator

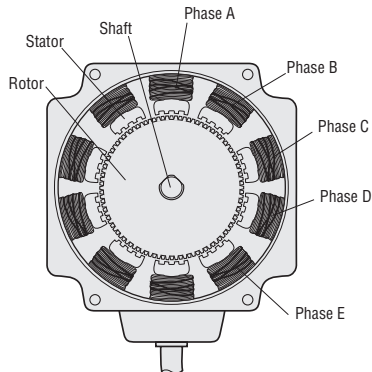

Motor Structural Diagram: Cross-Section Perpendicular to Shaft

Stepping Motor's Principle of Operation

Following is an explanation of the relationship between the magnetized stator small teeth and rotor small teeth.

When Phase "A" is Excited

When phase A is excited, its poles are polarized south. This attracts the teeth of rotor 1, which are polarized north, while repelling the teeth of rotor 2, which are polarized south. Therefore, the forces on the entire unit in equilibrium hold the rotor stationary. At this time, the teeth of the phase B poles, which are not excited, are misaligned with the south-polarized teeth of rotor 2 so that they are offset 0.72°. This summarizes the relationship between the stator teeth and rotor teeth with phase A excited.

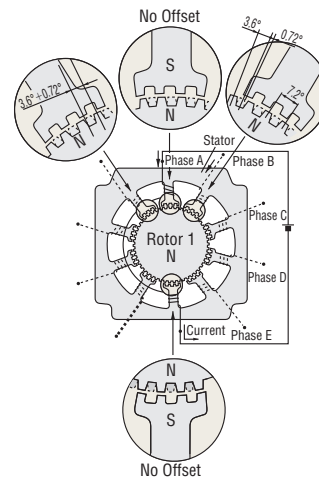

When Phase "B" is Excited

When excitation switches from phase A to B, the phase B poles are polarized north, attracting the south polarity of rotor 2 and repelling the north polarity of rotor 1.

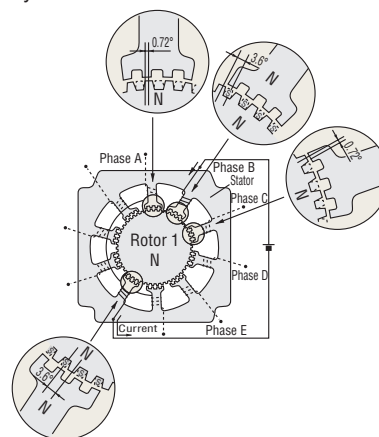

In other words, when excitation switches from phase A to B, the rotor rotates by 0.72° . As excitation shifts from phase A, to phases B, C, D and E, then back around to phase A, the stepping motor rotates precisely in 0.72° steps. To rotate in reverse, reverse the excitation sequence to phase A, E, D, C, B, then back around to phase A. The high resolution of 0.72° is inherent in the mechanical offset between the stator and rotor, accounting for the achievement of precise positioning without the use of an encoder or other sensors. High stopping accuracy of ± 3 arc minutes (with no load) is obtained, since the only factors affecting stopping accuracy are variations in the machining precision of the stator and rotor, assembly precision and DC resistance of windings. The driver performs the role of phase switching, and its timing is controlled by a pulse-signal input to the driver. The previous example shows the excitation advancing one phase at a time, but in an actual stepping motor an effective use of the windings is made by exciting four or five phases simultaneously.

Basic Characteristics of Stepping Motors

An important point to consider in the application of stepping motors is whether the motor characteristics are suitable to the operating conditions.

The following sections describe the characteristics to be considered in the application of stepping motors.

The two main characteristics of stepping motor performance are:

Dynamic Characteristics:

These are the starting and rotational characteristics of a stepping motor, mainly affecting the machinery's movement and cycling time.

Static Characteristics:

These are the characteristics relating to the changes in angle that take place when the stepping motor is in standstill mode, affecting the machinery's level of precision.

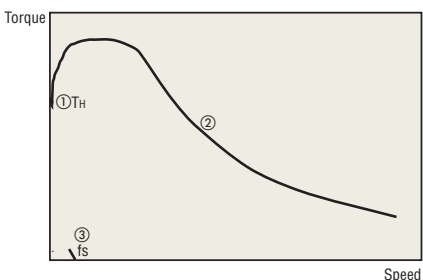

Speed - Torque Characteristics

Dynamic Characteristics

◇ Speed - Torque Characteristics

The figure above is a characteristics graph showing the relationship between the speed and torque of a driven stepping motor. These characteristics are always referred to in the selection of a stepping motor. The horizontal axis represents the speed at the motor output shaft, and the vertical axis represents the torque. The speed - torque characteristics are determined by the motor and driver, and are greatly affected by the type of driver being used.

① Maximum holding torque (T_H)

The maximum holding torque is the stepping motor's maximum holding power (torque) when power is supplied (at rated current) when the motor is not rotating.

② Pullout torque

The pullout torque is the maximum torque that can be output at a given speed.

When selecting a motor, be sure the required torque falls within this curve.

③ Maximum starting frequency (f_s)

This is the maximum pulse speed at which the motor can start or stop instantly (without an acceleration/deceleration time) when the stepping motor's friction load and inertial load are 0.

Driving the motor at a pulse speed in excess of this rate will require a gradual acceleration or deceleration. This frequency will decrease when an inertial load is added to the motor. Refer to the inertial load - starting frequency characteristics below.

Maximum response frequency (f_r)

This is the maximum pulse speed at which the motor can be operated through gradual acceleration or deceleration when the stepping motor's friction load and inertial load are 0.

The figure below shows the speed - torque characteristics of a 0.72° stepping motor and driver package.

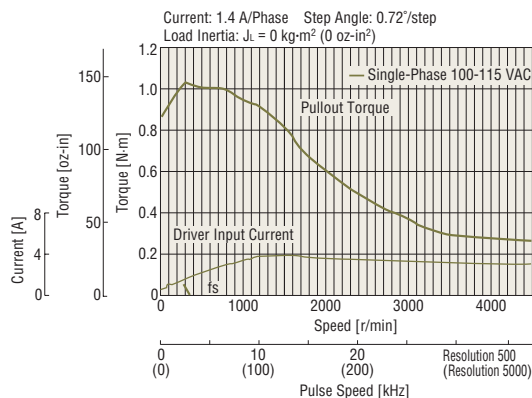

◇ Inertial Load - Starting Frequency Characteristics

These characteristics show the changes in the starting frequency caused by the load inertia.

Since the stepping motor's rotor and load have their own moment of inertia, lags and advances occur on the motor axis during instantaneous starting and stopping. These values change with the pulse speed, but the motor cannot follow the pulse speed beyond a certain point, so that missteps result.

The pulse speed immediately before the occurrence of a misstep is called the starting frequency.

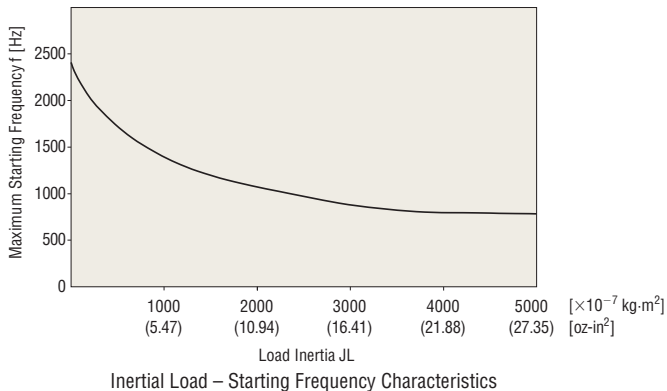

Inertial Load - Starting Frequency Characteristics

Changes in maximum starting frequency with the inertial load may be approximated via the following formula:

$$f = \frac{f_s}{\sqrt{1 + \frac{J_L}{J_0}}} \text{ [Hz]}$$

- f_s : Maximum starting frequency of motor [Hz]
- f : Maximum starting frequency where inertial load is present [Hz]
- J_0 : Moment of inertia of rotor [$\text{kg}\cdot\text{m}^2$ (oz-in²)]
- J_L : Moment of inertia of load [$\text{kg}\cdot\text{m}^2$ (oz-in²)]

◇ Vibration Characteristics

The stepping motor rotates through a series of stepping movements. A stepping movement may be described as a 1-step response, as shown below:

- ① A single pulse input to a stepping motor at a standstill accelerates the motor toward the next stop position.
- ② The accelerated motor rotates through the stop position, overshoots a certain angle, and is pulled back in reverse.
- ③ The motor settles to a stop at the set stop position following a damping oscillation.

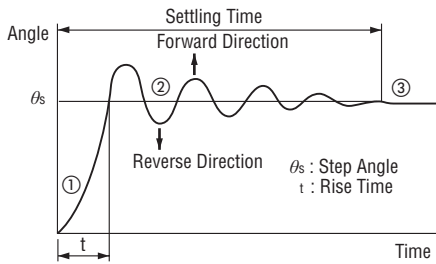

1-Step Response

Vibration at low speeds is caused by a step-like movement that produces this type of damping oscillation.

The vibration characteristics graph below represents the magnitude of vibration of a motor in rotation.

The lower the vibration level, the smoother the motor rotation will be.

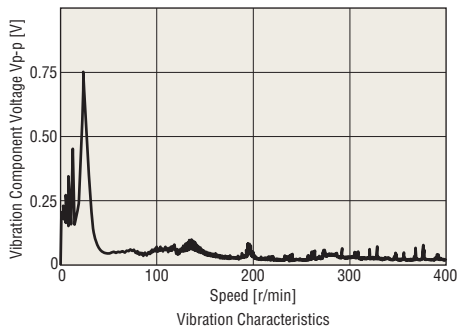

Vibration Characteristics

● Static Characteristics

◇ Angle – Torque Characteristics

The angle – torque characteristics show the relationship between the angular displacement of the rotor and the torque externally applied to the motor shaft while the motor is excited at the rated current. The curve for these characteristics is shown below:

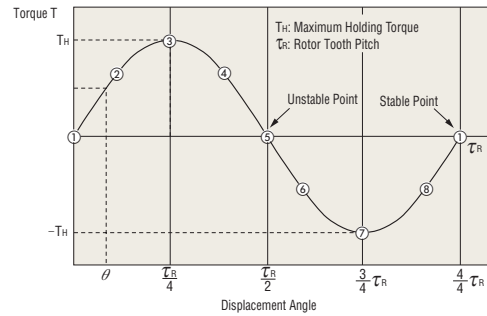

Angle – Torque Characteristics

The following illustrations show the positional relationship between the rotor teeth and stator teeth at the numbered points in the diagram above.

When held stable at point ① the external application of a force to the motor shaft will produce torque $T (+)$ in the left direction, trying to return the shaft to stable point ①. The shaft will stop when the external force equals this torque at point ②.

If additional external force is applied, there is an angle at which the torque produced will reach its maximum at point ③. This torque is called the maximum holding torque T_H .

Application of external force in excess of this value will drive the rotor to an unstable point ⑤ and beyond, producing torque $T (-)$ in the same direction as the external force, so that it moves to the next stable point ① and stops.

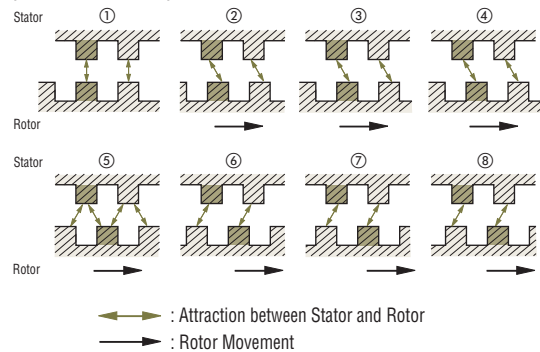

Stable Points:

Points where the rotor stops, with the stator teeth and rotor teeth are exactly aligned. These points are extremely stable, and the rotor will always stop there if no external force is applied.

Unstable Points:

Points where the stator teeth and rotor teeth are half a pitch out of alignment. A rotor at these points will move to the next stable point to the left or right, even under the slightest external force.

◇ Angle Accuracy

Under no load conditions, a stepping motor has an angle accuracy within ± 3 arc minutes ($\pm 0.05^\circ$). The small error arises from the difference in mechanical precision of the stator and rotor and a small variance in the DC resistance of the stator winding.

Generally, the angle accuracy of the stepping motor is expressed in terms of the stop position accuracy, as described on the right.

Stop Position Accuracy:

The stop position accuracy is the difference between the rotor's theoretical stopping position and its actual stopping position. A given rotor stopping point is taken as the starting point, then the stop position accuracy is the difference between the maximum (+) value and maximum (-) value in the set of measurements taken for each step of a full rotation.

Actual Stopping Position

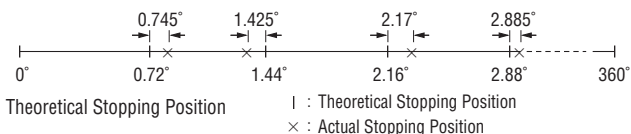

The stop position accuracy is within ± 3 arc minutes ($\pm 0.05^\circ$), but only under no load conditions. In actual applications there is always the same amount of friction load.

The angle accuracy in such cases is produced by the angular displacement caused by the angle – torque characteristics based upon the friction load. If the friction load is constant, the displacement angle will be constant for uni-directional operation. However, in bi-directional operation, double the displacement angle is produced over a round trip.

When high stopping accuracy is required, always position in the same direction.

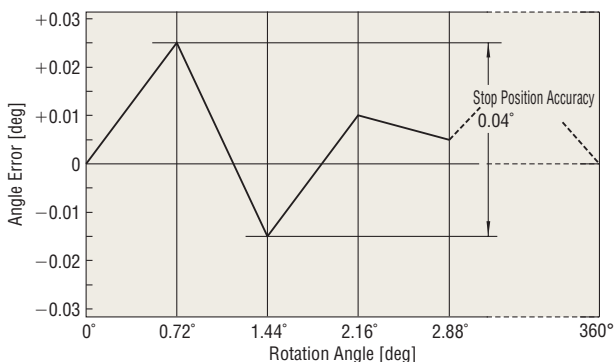

Excitation Sequence of Stepping Motor and Driver Packages

Every 0.72° motor and driver package listed in our catalog consists of a New Pentagon, five-lead wire motor and a driver incorporating a special excitation sequence. This combination, which is proprietary to Oriental Motor, offers the following benefits:

- Simple connections for five leads
- Low vibration

The following sections describe the wiring and excitation sequence.

● New Pentagon, 4-Phase Excitation: Full Step System ($0.72^\circ/\text{step}$)

This is a system unique to the 0.72° motor, in which four phases are excited. The step angle is 0.72° . It offers a great damping effect, and therefore stable operation.

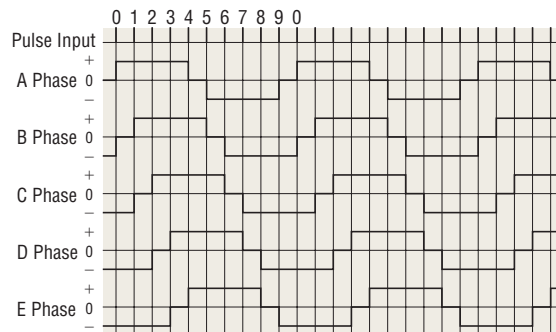
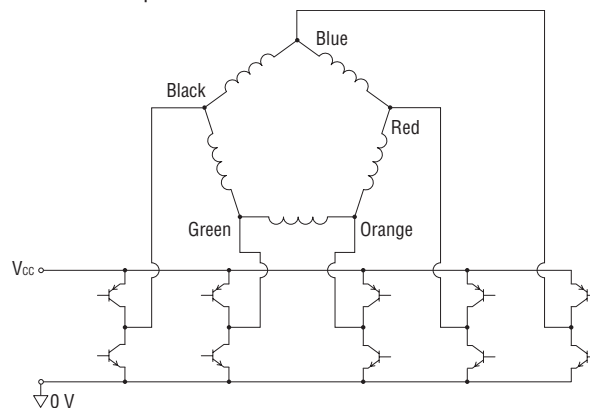

New Pentagon, 4-Phase Excitation Sequence

● New Pentagon, 4-5-Phase Excitation: Half-Step System ($0.36^\circ/\text{step}$)

A step sequence of alternating the 4-phase and 5-phase excitation produces rotation at 0.36° per step. One rotation may be divided into 1000 steps.

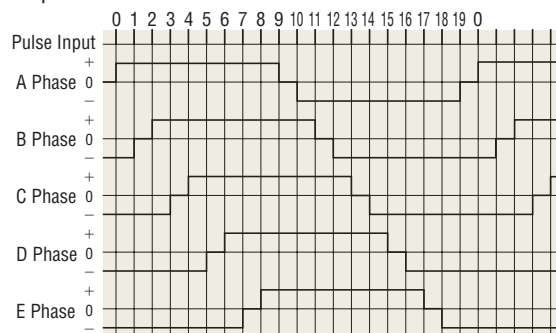

New Pentagon, 4-5-Phase Excitation Sequence

- Motors
- Linear and Rotary Actuators
- Selection Calculations
- Cooling Fans
- Service Life
- Stepping Motors
- Servo Motors
- Standard AC Motors
- Brushless Motors/AC Speed Control Motors
- Gearheads
- Linear and Rotary Actuators
- Cooling Fans

Stepping Motor Drivers

There are two common systems of driving a stepping motor: constant current drive and constant voltage drive.

The circuitry for the constant voltage drive is simpler, but it's relatively more difficult to achieve torque performance at high speeds.

The constant current drive, on the other hand, is now the most commonly used drive method, since it offers excellent torque performance at high speeds. All Oriental Motor's drivers use the constant current drive system.

Overview of the Constant Current Drive System

The stepping motor rotates through the sequential switching of current flowing through the windings. When the speed increases, the switching rate also becomes faster and the current rise falls behind, resulting in lost torque.

The chopping of a DC voltage that is far higher than the motor's rated voltage will ensure the rated current reaches the motor, even at higher speeds.

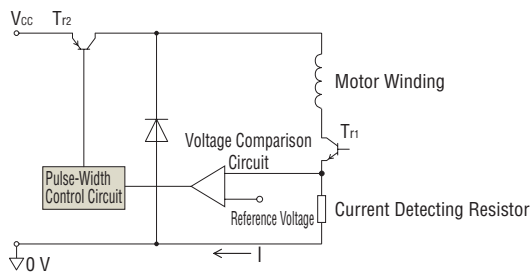

The current flowing to the motor windings, detected as a voltage through a current detecting resistor, is compared to the reference voltage. Current control is accomplished by holding the switching transistor T_{r2} ON when the voltage across the detecting resistor is lower than the reference voltage (when it hasn't reached the rated current), or turning T_{r2} OFF when the value is higher than the reference voltage (when it exceeds the rated current), thereby providing a constant flow of rated current.

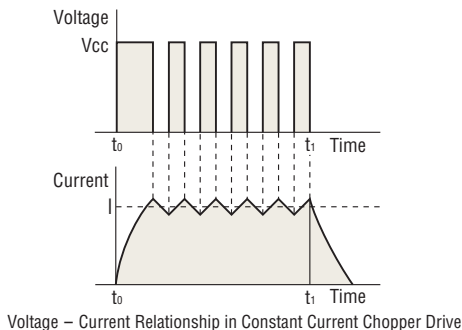

Differences between AC Input and DC Input Characteristics

A stepping motor is driven by a DC voltage applied through a driver. In Oriental Motor's 24 VDC input motor and driver packages, 24 VDC is applied to the motor. In the 100-115 VAC motor and driver packages the input is rectified to DC and then approximately 140 VDC is applied to the motor. (Certain products are exceptions to this.)

This difference in voltages applied to the motors appears as a difference in torque characteristics at high speeds. This is due to the fact that the higher the applied voltage is, the faster the current rise through the motor windings will be, facilitating the application of rated current at higher speeds. Thus, the AC input motor and driver package has superior torque characteristics over a wide speed range, from low to high speeds.

It is recommended that AC input motor and driver packages, which are compatible with a wider range of operating conditions, be considered for your applications.

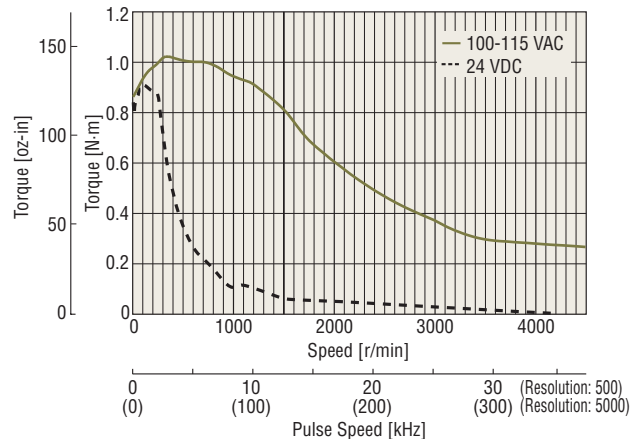

Microstep Technology

Microstep drive technology is used to divide the basic step angle (0.72°) of the 0.72° stepping motor into smaller steps (up to a maximum of 250 divisions) without the use of a speed reduction mechanism.

Features

The stepping motor moves and stops in increments of the step angle determined by the rotor and stator's salient pole structure, easily achieving a high degree of precision in positioning. The stepping motor, on the other hand, causes the rotor speed to vary because the motor rotates in step angle increments, resulting in resonance or greater vibration at a given speed.

Microstepping is a technology that achieves low resonance, low noise operation at extremely low speeds by controlling the flow of electric current fed to the motor coil and thereby dividing the motor's basic step angle into smaller steps.

- The motor's basic step angle (0.72° /full step) can be divided into smaller steps ranging from 1/1 to 1/250. Microstepping thus ensures smooth operation.
- With the technology for smoothly varying the motor drive current, motor vibration can be minimized for low noise operation.

Up to 250 Microsteps based on Basic Step Angle

Thanks to the microstep driver, different step angles (16 steps up to 250 divisions) can be set to two step angle setting switches. By controlling the input signal for step angle switching via an external source, it is possible to switch the step angle between the levels set for the respective switches.

Features of Microstep Drive

• Low Vibration

Microstep drive technology electronically divides the step angle into smaller steps, ensuring smooth incremental motion at low speeds and significantly reducing vibration.

While a damper or similar device is generally used to reduce vibration, the low vibration design employed for the motor itself — along with the microstep drive technology — minimizes vibration more effectively.

Anti-vibration measures can be dramatically simplified, so it's ideal for most vibration sensitive applications and equipment.

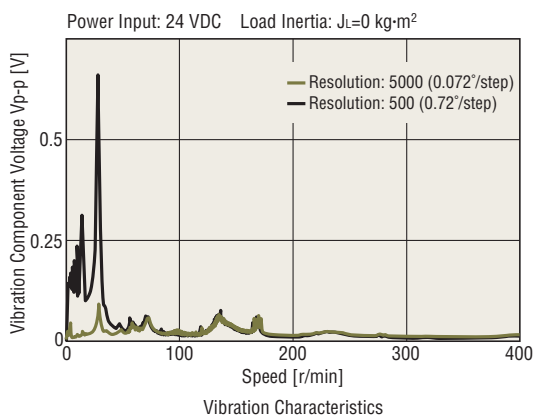

• Low Noise

Microstep drive technology effectively reduces the vibration related noise level at low speeds, achieving low noise performance.

The motor demonstrates outstanding performance in even the most noise sensitive environment.

• Improved Controllability

The New Pentagon microstep driver, with its superior damping performance, minimizes overshoot and undershoot in response to step changes, accurately following the pulse pattern and ensuring improved linearity.

In addition, shock normally resulting from the motions of starting and stopping can be lessened.

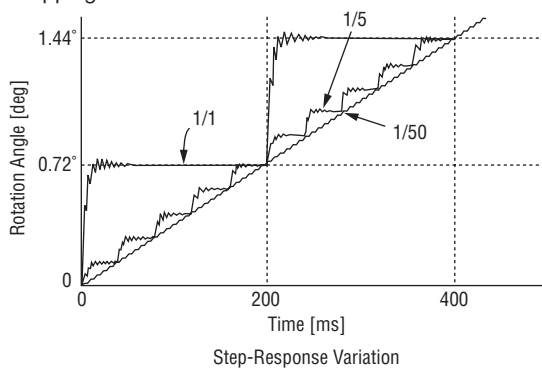

- Motors
- Selection Calculations
- Linear and Rotary Actuators
- Cooling Fans
- Service Life
- Stepping Motors
- Servo Motors
- Standard AC Motors
- Brushless Motors/AC Speed Control Motors
- Gearheads
- Linear and Rotary Actuators
- Cooling Fans

Stepping Motor and Driver Package

α STEP

Overview of the Control System

◇ Sensor to Detect Rotor's Position

A rotor position detection sensor is built onto the rear end of the motor output shaft.

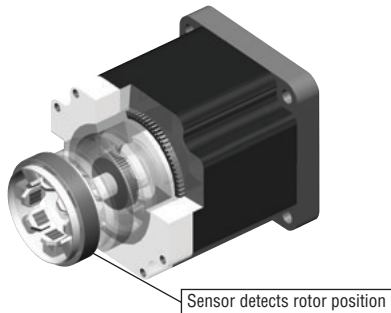

The sensor winding detects changes in magnetic reluctance due to the angular position of the rotor.

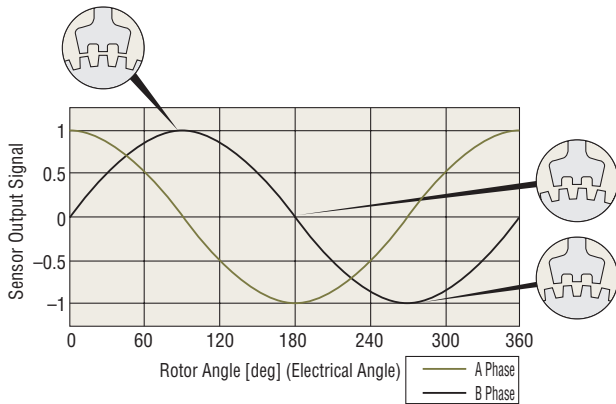

Output Signal of Rotor Position Detection Sensor

◇ Featuring Innovative Closed Loop Control

The deviation counter calculates the deviation (lag/advance) of the rotor's actual angular position with regard to the position command by the pulse signal.

The calculation result is used to detect a "misstep region" and operate the motor by switching between open loop and closed loop modes.

- If the positioning deviation is less than $\pm 1.8^\circ$, the motor runs in the open loop mode.
- If the positioning deviation is $\pm 1.8^\circ$ or more, the motor runs in closed loop mode.

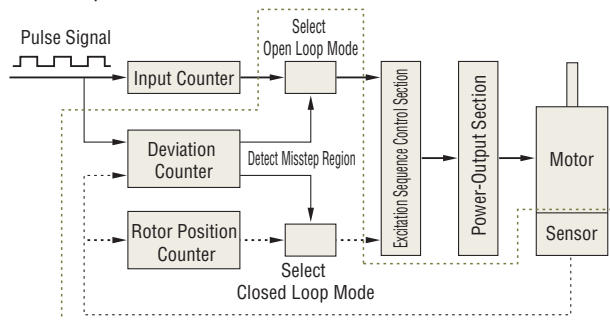

: Unique Control Section of α STEP

Rotor Position Counter: Specifies an excitation sequence that would develop maximum torque for a given rotor position.

α STEP Control Diagram

In the closed loop mode, motor-winding excitation is controlled so that maximum torque is developed for the given angular position of the rotor.

This control method eliminates unstable points (misstep region) in the angle – torque characteristics.

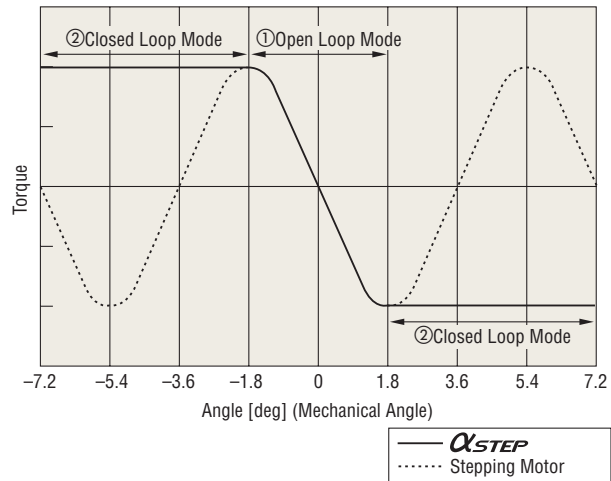

Angle – Torque Characteristics

Features of α STEP

◇ Improved Stepping Motor Performance

- At high speeds α STEP will not "misstep." Therefore, unlike conventional stepping motors, the α STEP operation will be free of the following restrictions:
 - Restrictions on starting pulse speed caused by "misstep."
 - Use the velocity filter to adjust responsiveness while starting/stopping
- The responsiveness of starting/stopping can be adjusted with 16 settings without changing the controller data (starting pulse, acceleration/deceleration rates). This feature is intended to reduce shock to the work and vibration during low speed operation.

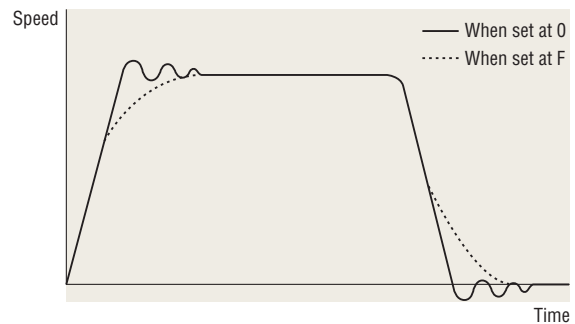

Effect of Velocity Filter

Return to Mechanical Home Operation Using Excitation Timing Signal

Excitation Timing Signal

The excitation timing (TIM.) signal is output when the driver is initially exciting the stepping motor (step "0").

Oriental Motor's 0.72° stepping motor and driver packages perform initial excitation when the power is turned on, and advance the excitation sequence each time a pulse signal is input, completing one cycle when the motor shaft rotates 7.2°.

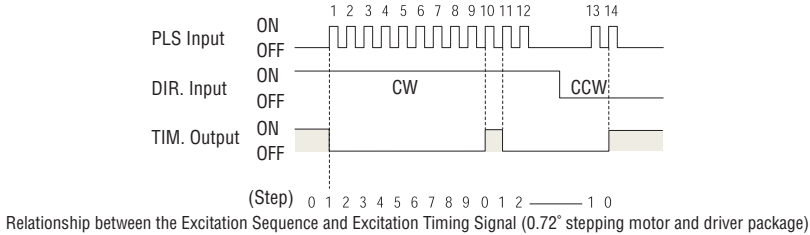

Use these timing signals when it is necessary to perform highly reproducible return to mechanical home operation. The following sections describe stepping motor return to mechanical home operation and the use of timing signals.

Return to Mechanical Home Operation for Stepping Motors

When turning on the power to start automated equipment or restarting the equipment after a power failure, it is necessary to return stepping motors to their standard position. This operation is called the "return to mechanical home operation."

The return to mechanical home operation for stepping motors uses home sensors to detect the mechanical component used for the positioning operation. When the detected signals are confirmed, the controller stops the pulse signal, and the stepping motor is stopped.

The accuracy of the home position in such a return to mechanical home operation depends on the detection performance of the home sensors. As the detection performance of the home sensors varies according to factors such as the ambient temperature and approach speed of the mechanism detection area, it's necessary to reduce these factors for applications that require a highly reproducible mechanical home position detecting.

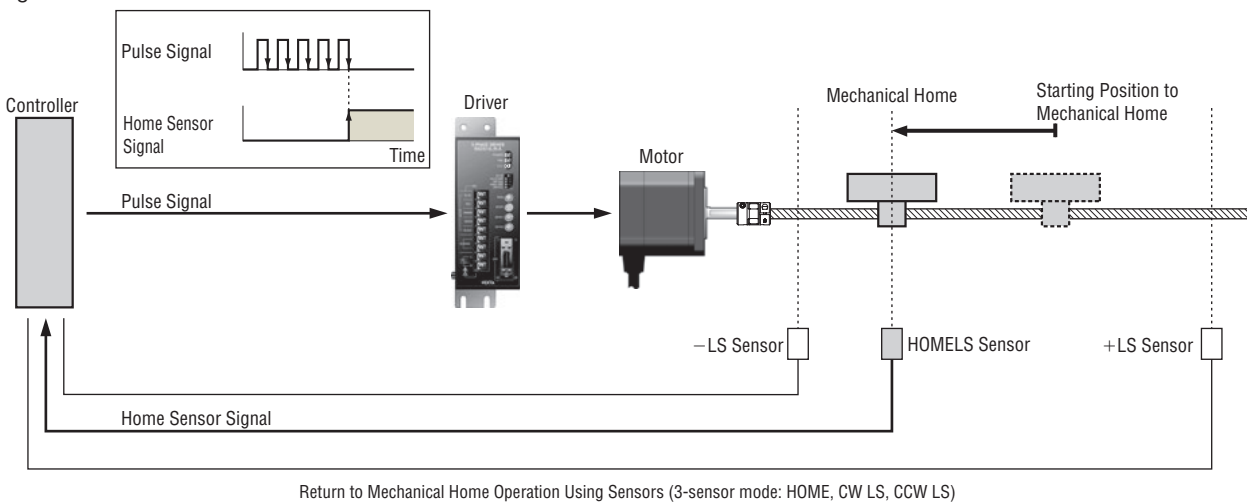

Improved Reproducibility Using Excitation Timing Signal

A method of ensuring that the mechanical home position does not vary due to variations in the detection performance of the home sensors, is to stop the pulse signal by logically multiplying with the timing signal. As the timing signal is output at initial excitation. If the pulse signal is stopped when the timing signal is output, the mechanical home position will always be determined at initial excitation.

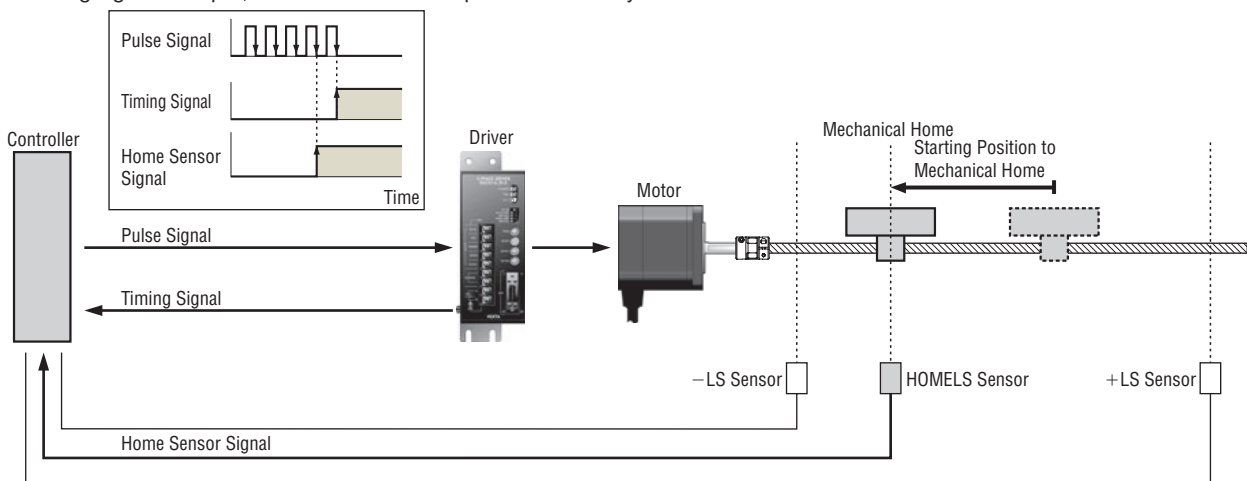

Relationship between Cable Length and Transmission Frequency

As the pulse line cable becomes longer, the maximum transmission frequency decreases. Specifically, the resistive component and stray capacitance of the cable cause the formation of a CR circuit, thereby delaying the pulse rise and fall times.

Stray capacitance in a cable occurs between electrical wires and ground planes. However, it is difficult to provide distinct numerical data, because conditions vary according to the cable type, layout, routing and other factors.

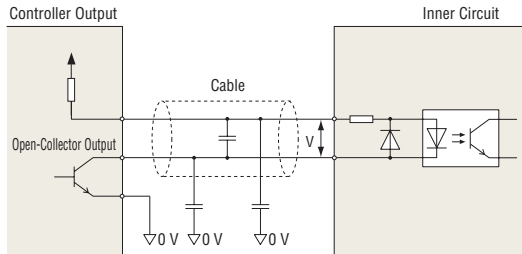

Image Diagram of Stray Capacitance in a Cable

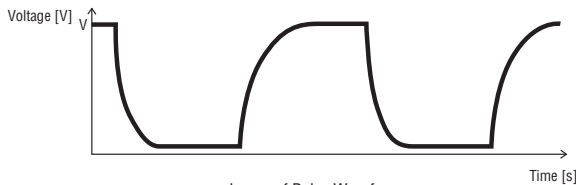

Image of Pulse Waveform

The transmission frequency when operated in combination with our products (actual-measurement reference values) are shown below:

Maximum Transmission Frequency (Reference value)

Driver	Controller	Cable	Maximum Transmission Frequency
RK Series	EMP400 Series	CC01EMP5 [1 m (3.3 ft.)]	170 KHz
		CC02EMP5 [2 m (6.6 ft.)]	140 KHz

Effect of Coupling Rigidity on Equipment

The specifications that indicate coupling performance include permissible load, permissible speed, torsional spring constant, backlash (play) in the coupling, and permissible misalignment. In practice, when selecting couplings for equipment that requires high positioning performance or low vibration, the primary selection criteria would be "rigid, with no backlash."

However, in some cases coupling rigidity has only a slight effect on the equipment's overall rigidity.

This section provides an example by comparing the overall rigidity of equipment consisting of a ball screw drive in two applications where a jaw coupling such as an **MCS** and a bellows coupling offering higher rigidity are used. (Data is taken from KTR's technical document, for which reason the coupling dimensions differ from the products offered by Oriental Motor.)

Overview of Test Equipment

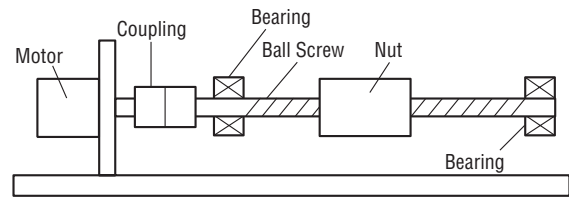

Equipment with Ball Screw Drive

Specifications of Parts

Torsional spring constant of jaw coupling

$$C_j = 21000 \text{ [N}\cdot\text{m/rad]}$$

Torsional spring constant of bellows coupling

$$C_b = 116000 \text{ [N}\cdot\text{m/rad]}$$

Servo motor rigidity

$$C_m = 90000 \text{ [N}\cdot\text{m/rad]}$$

Ball screw lead

$$h = 10 \text{ [mm]}$$

Ball screw root circle diameter

$$d = 28.5 \text{ [mm]}$$

Ball screw length

$$L = 800 \text{ [mm]}$$

Bearing rigidity in axial direction

$$R_{brg} = 750 \text{ [N/}\mu\text{m]}$$

Rigidity in axial direction of ball screw nut

$$R_n = 1060 \text{ [N/}\mu\text{m]}$$

Modulus of elasticity of ball screw

$$R_f = 165000 \text{ [N/mm}^2\text{]}$$

① Obtain the torsional rigidity of the ball screw, bearing and nut.

The rigidity in the axial direction of the ball screw R_s is calculated as follows:

$$\begin{aligned} R_s &= (R_f \times d^2) / L \\ &= (165000 \times 28.5^2) / 800 \\ &= 167526 \text{ [N/mm]} \\ &= 167.5 \text{ [N/}\mu\text{m]} \end{aligned}$$

Therefore, the total rigidity in the axial direction of the ball screw, bearing and nut R_t is calculated as follows:

$$\begin{aligned} \frac{1}{R_t} &= \frac{1}{2R_{brg}} + \frac{1}{R_s} + \frac{1}{R_n} \\ &= \frac{1}{2 \times 750} + \frac{1}{167.5} + \frac{1}{1060} \\ &= 0.00758 \end{aligned}$$

$$\therefore R_t = 131.9 \text{ [N/}\mu\text{m]}$$

This rigidity in the axial direction is applied as torsional rigidity C_t .

$$\begin{aligned} C_t &= R_t \left(\frac{h}{2\pi} \right)^2 \\ &= 131.9 \times 10^6 \times \left(\frac{10 \times 10^{-3}}{2\pi} \right)^2 \\ &= 334.1 \text{ [N}\cdot\text{m/rad]} \end{aligned}$$

② Obtain the overall equipment rigidity C when a jaw coupling is used.

$$\begin{aligned} \frac{1}{C} &= \frac{1}{C_m} + \frac{1}{C_j} + \frac{1}{C_t} \\ &= \frac{1}{90000} + \frac{1}{21000} + \frac{1}{334.1} \\ &= 0.003052 \end{aligned}$$

$$\therefore C = 327.7 \text{ [N}\cdot\text{m/rad]}$$

- ③ Obtain the overall equipment rigidity C when a bellows coupling is used.

$$\begin{aligned} \frac{1}{C} &= \frac{1}{C_m} + \frac{1}{C_b} + \frac{1}{C_r} \\ &= \frac{1}{90000} + \frac{1}{116000} + \frac{1}{334.1} \\ &= 0.0030128 \\ \therefore C &= 331.9 \text{ [N·m/rad]} \end{aligned}$$

- ④ Calculation results

	Coupling Rigidity [N·m/rad]	Overall Equipment Rigidity [N·m/rad]
Jaw Coupling	21000	327.7
Bellows Coupling	116000	331.9

The rigidity of the jaw coupling is one-fifth the rigidity of the bellows coupling, but the difference in overall equipment rigidity is 1.2%.

Glossary

● CW, CCW

The rotation direction of motor is expressed as CW (clockwise) or CCW (counterclockwise). These directions are as seen from the output shaft.

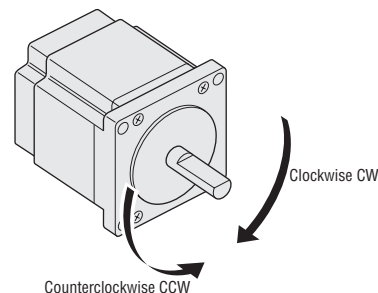

● Overhung Load

The load on the motor shaft in the vertical direction. The value varies with the model.

● Angle Accuracy

The difference between the actual rotation angle and the theoretical rotation angle. Although there are several expressions according to how the criteria are set, generally, the angle accuracy of the stepping motor is expressed in terms of the stop position accuracy.

● Angular Transmission Accuracy

Angular transmission accuracy is the difference between the theoretical rotation angle of the output shaft, as calculated from the input pulse number, and the actual rotation angle. It is generally observed when a reduction mechanism is provided. Angular transmission accuracy is used to represent the accuracy of a reduction mechanism. Oriental Motor's planetary (**PN**) gear is designed to minimize the angular transmission accuracy to a maximum of only six arc minutes, and may be effectively used in high accuracy positioning and indexing applications.

Angular Transmission Accuracy

Frame Size [mm]	Angular Transmission Accuracy [min]
28, 42	6 (0.1°)
60	5 (0.09°)
90	4 (0.07°)

● Inertial Load (Moment of Load Inertia)

This is the degree of force possessed by a physical object to maintain its current level of kinetic energy. Every physical object has an inherent inertial load. Greater torque is required to accelerate and decelerate an object having a larger inertial load. The degree of such torque is proportional to the degree of inertial load and the acceleration that is obtained from the operating speed and acceleration time.

● Automatic Current Cutback Function

This is a function used for the automatic reduction of motor current by approximately 50% when the pulse signal is not input, in order to minimize the heating of the motor and driver.

(Approximately 40% in **CMK** Series, **RBK** Series and **UMK** Series stepping motors)

This function automatically reduces the motor current at motor standstill, and does so within approximately 0.1 second after the pulse signal stops.

$$\text{Holding torque [N·m (oz-in)]} = \frac{\text{Maximum holding torque [N·m (oz-in)]} \times \text{Current at motor standstill [A]}}{\text{Rated motor current [A]}}$$

● Resonance

This refers to the phenomenon in which vibration becomes larger at specific speeds. Resonance is a result of the characteristic vibration frequency and operating vibration of a motor or other mechanism. For 1.8° stepping motors, there are resonance areas between 100 Hz and 200 Hz; 0.72° stepping motors have lower levels of resonance.

● Thrust Load

The thrust load is the load in the direction of the motor output shaft. The value varies with the model.

● Misstep

Stepping motors are synchronized by pulse signals. They can lose their synchronization when speed changes rapidly or an overload occurs. Misstep is the term for losing synchronization with the input pulse. The correctly selected and normally operated motor doesn't suffer a sudden misstep. Essentially, misstep is a condition in which an overload alarm occurs with a servo motor.

● Twisted-Pair Wire

Twisted-pair wires entwine two wires as shown in the figure below. They are used to reduce noise in signal wires. Because the wires face in opposite directions from each other and carry the same current, noise from the ambient surroundings is cancelled out and noise effects reduced.

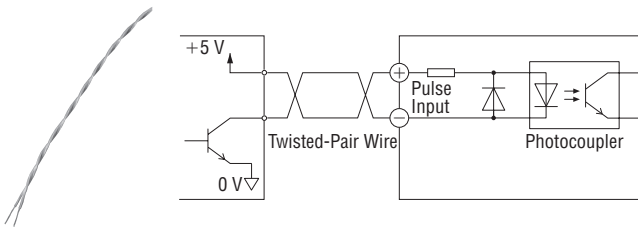

● Backlash

Backlash is a term used to describe the play in a gear or coupling. Since the range of backlash angle cannot be controlled, minimizing the backlash will help improve the accuracy of positioning. Oriental Motor provides harmonic gears and **PN** gears that have non-backlash, as well as **PS** gears, **PL** gears and **TH** gears with reduced backlash (low backlash).

● Pulse Input Mode

The pulse mode used when the CW/CCW rotation direction is controlled by the pulse command. The pulse input configuration may be 1-pulse (1P) input mode or 2-pulse (2P) input mode. The 1-pulse input mode uses the pulse signal and rotation direction signal, while the 2-pulse input mode uses the CW pulse input for the CW direction and the CCW pulse input for the CCW direction.

● Photocoupler "ON" "OFF"

Photocouplers are electronic components that relay electrical signals as light. They are electronically insulated on the input and output sides, so noise has little effect on them. Input (output) "ON" indicates that the current is sent into the photocoupler (transistor) inside the driver. Input (output) "OFF" indicates that the current is not sent into the photocoupler (transistor) inside the driver.



● Gravitational Operation

Gravitational operation refers to the downward movement of a lifted load. Since the motor is operating by gravity, the servo motor used in this application generates electricity. To prevent damage to the driver as a result of the electricity thus generated, a regeneration circuit is required. The operation of stepping motors, including our **αSTEP**, is synchronized with pulses, enabling speed control even during gravitational operation.

● Excitation Home Position

Condition in which the excitation sequence is in its initial condition. In the 0.72° stepping motor, the sequence returns to the initial condition at 7.2° intervals.

● Excitation Sequence

The stepping motor rotates by sending current to the motor coils according to a preset combination and order. The excitation sequence is the order in which current is sent to the motor coils. It varies with the types of motor and excitation system.

Servo Motors

Structure of Servo Motors

The servo motor has a rotation detector (encoder) mounted on the back shaft side of the motor to detect the position and speed of the rotor. This enables high resolution, high response positioning operation.

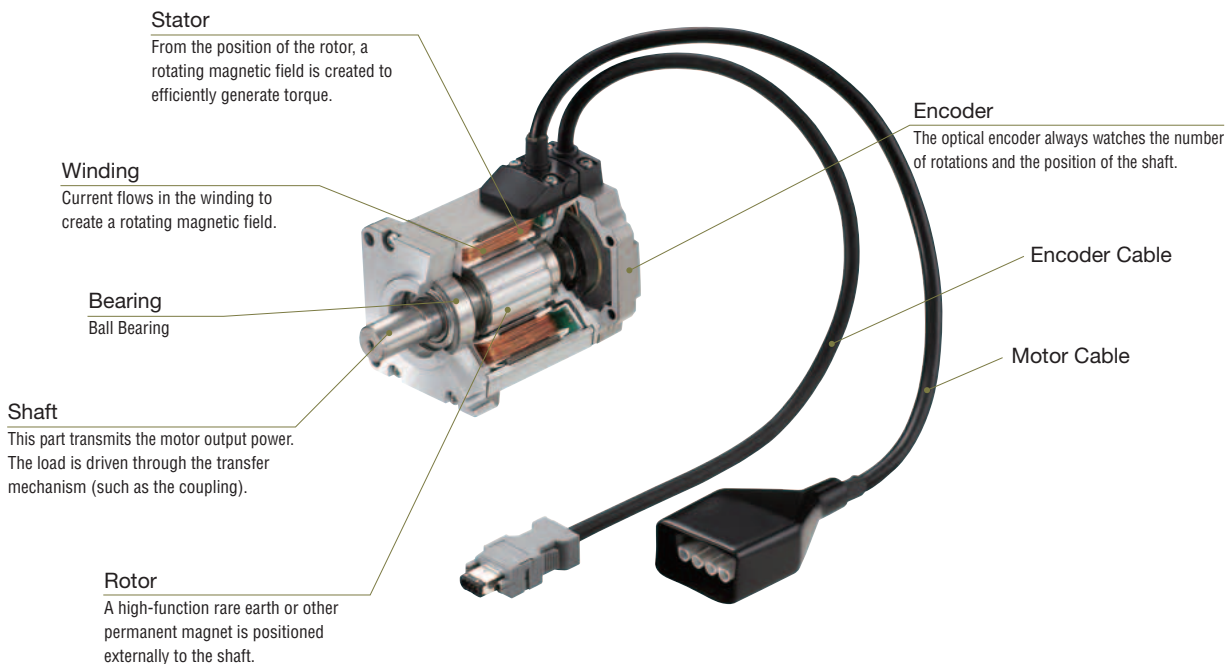

The encoder is a sensor for detecting the speed and position of the motor. Light from the light-emitting diode (LED) passes through a position detection pattern on the slit disk and is read by the light-receiving element. Dozens of phototransistors are integrated in the light-receiving element. All of the patterns for absolute position detection depend on the rotation angle of the encoder. The CPU is mounted on the encoder for analysis of the absolute position detection patterns. The current position data is transmitted to the servo driver via serial transmission.

- Motors
- Selection Calculations
- Linear and Rotary Actuators
- Cooling Fans
- Service Life
- Stepping Motors
- Servo Motors
- Standard AC Motors
- Brushless Motors/AC Speed Control Motors
- Gearheads
- Linear and Rotary Actuators
- Cooling Fans

Control Block Diagram of the Servo Motor

A pulse signal that is externally applied (when it is the pulse input type) and the rotation detected by the servo motor encoder, are counted and the difference (deviation) is outputted to the speed control unit. This counter is referred to as the deviation counter.

During motor rotation, an accumulated pulse (positioning deviation) is generated in the deviation counter and is controlled so as to go to zero. The (position holding by servo control) function for holding the current position is achieved with a position loop (deviation counter).

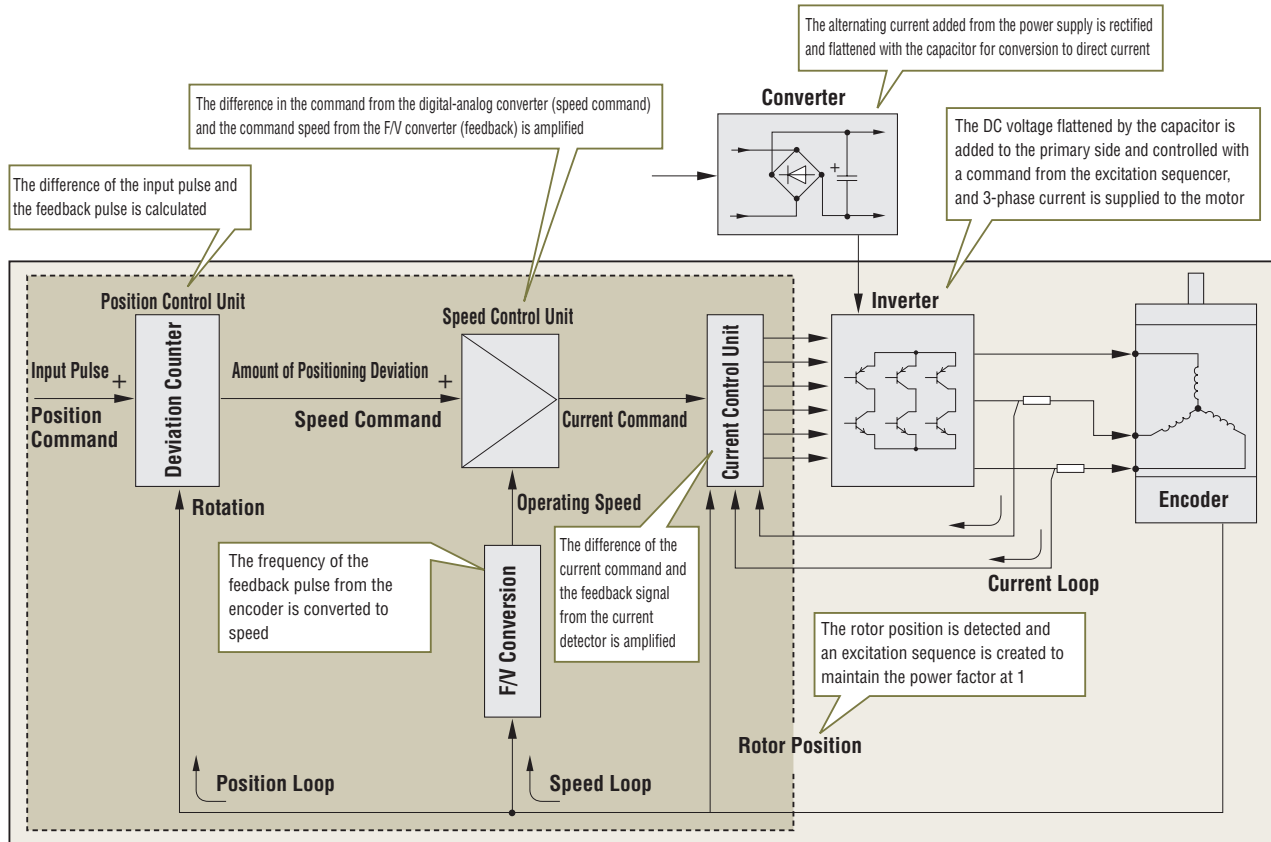

The servo motor is composed of three elements: the motor, the encoder and the driver. The driver has the role of comparing the position command and the encoder position/speed information and controlling the drive current. The servo motor always detects the motor condition from the encoder position and speed information. If the motor should come to a standstill, the servo motor outputs an alarm signal to the controller for abnormality detection. The servo motor must adjust the control system parameters to match the rigidity of the mechanism and the load conditions, though in recent years, real time auto-tuning has made this adjustment easy.

Glossary

Encoder

The encoder is a sensor that notifies the driver of the speed and position of the motor.

The encoders (position detectors) used in the servo motor can be structurally classified as "incremental encoders" and "absolute encoders".

Oriental Motor uses a 20-bit absolute encoder for our servo motors **NX** series for low vibration at low speed range.

◇ Absolute Encoder

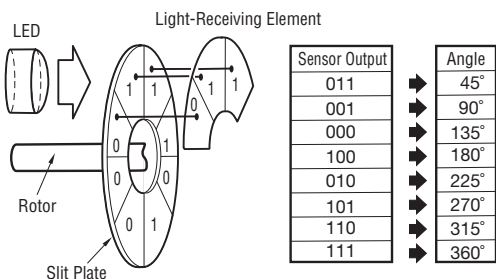

Capable of detecting absolute position within one rotation of the servo motor, the absolute encoder outputs the absolute position of the rotation angle.

Ordinarily, multiple rotation information is transmitted to the servo amp when the power source is turned on, and that information is then outputted to the current position data.

◇ Incremental Encoder

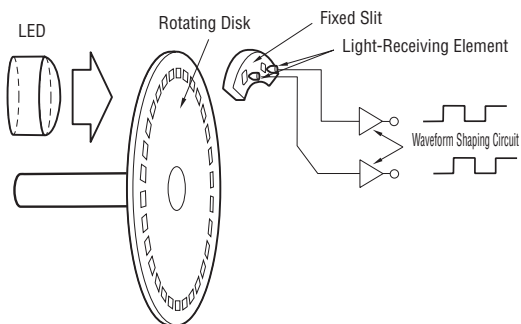

Capable of detecting the rotation, speed and rotation direction of the servo motor, the incremental encoder outputs the pulse with respect to the change portion of the rotation angle.

Ordinarily, the detection waveform output is without modification, and therefore the current position is lost when the power is off.

Resolution

The angle is shown for the motor rotation with one pulse.

The resolution determines the positioning accuracy of the motor. For example, if the resolution is 1000 p/rev, one rotation of the motor (360°) can be divided into 1000 parts.

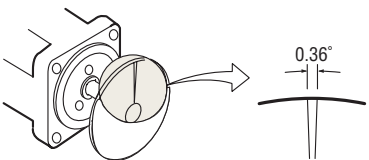

Speed Control and Position Control

The **NX** series speed and positioning control commands are carried out by inputting a pulse signal the same as with a stepping motor. In the relationship of the pulse speed and position,

- the rotation angle (position) is proportional to the number of pulses, and
- the speed is proportional to the pulse frequency.

Additionally, torque control and tension control are carried out.

Max. Input Pulse Frequency

This is the maximum pulse frequency (speed) that can be inputted to the driver.

The maximum rotation speed of the motor is limited by the driver. If a frequency exceeding that speed is input to the driver, the motor cannot follow and an alarm is outputted.

Photocoupler "ON" and "OFF"

Input (output) "ON" indicates that the current is sent into the photocoupler (transistor) inside the driver. Input (output) "OFF" indicates that the current is not sent into the photocoupler (transistor) inside the driver.

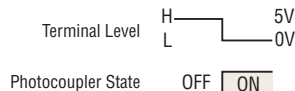

Pulse Speed

For the pulse input type, the motor speed is proportional to the input pulse speed (pulse frequency).

The Number of Pulses of One

$$\text{Pulse Speed } f \text{ [Hz]} = \frac{\text{Rotation of the Motor}}{60} \times \text{Speed [r/min]}$$

Deviation Counter

The deviation counter has the function of counting the deviation of the input pulse and the feedback pulse in the driver. When a pulse is input to the driver, the counter adds the pulse (accumulated pulse), and when the motor rotates, a positioning control is carried out so that the accumulated pulse in the counter is subtracted by the feedback signal and the accumulated pulse goes to zero.

Hunting

During a standstill, the output shaft of the servo motor may vibrate slightly. This phenomenon is called hunting.

Settling Time

A delay occurs between the position command of the pulse input and the actual motor operation. The time difference occurring at a motor standstill is referred to as the settling time.

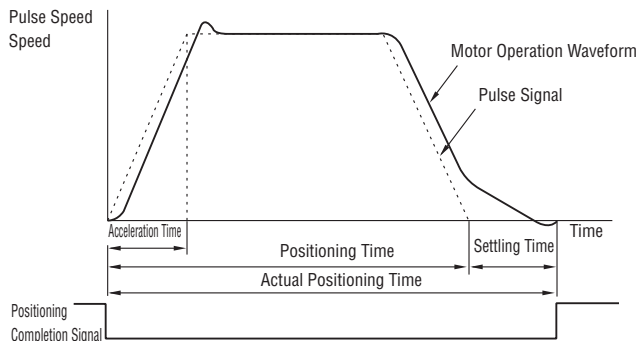

Gain Adjustment

Gain adjustment is carried out to optimize the control according to the load.

Accumulated Pulse

The difference of the command pulse input to the servo driver, and the feedback pulse output according to the motor rotation from the encoder that is built in the AC servo motor is referred to as the accumulated pulse.

- Motors
- Linear and Rotary Actuators
- Selection Calculations
- Cooling Fans
- Service Life
- Stepping Motors
- Servo Motors
- Standard AC Motors
- Brushless Motors/AC Speed Control Motors
- Gearheads
- Linear and Rotary Actuators
- Cooling Fans

Standard AC Motors

Structure of Standard AC Motors

The following figure shows the structure of a standard AC motor.

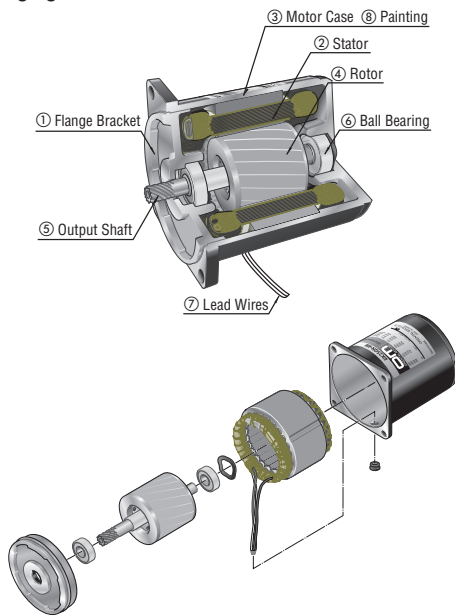

- ① Flange Bracket
Die cast aluminum bracket with a machined finish, press-fitted into the motor case
- ② Stator
Comprised of a stator core made from electromagnetic steel plates, a polyester-coated copper coil and insulation film
- ③ Motor case
Die cast aluminum with a machined finish inside
- ④ Rotor
Electromagnetic steel plates with die cast aluminum
- ⑤ Output shaft
Available in round shaft type and pinion shaft type
The metal used in the shaft is S45C. Round shaft type has a shaft flat (output power of 25 W 1/30 HP or more), while pinion shaft type undergoes precision gear finishing
- ⑥ Ball bearing
- ⑦ Lead wires
Lead wires with heat-resistant polyethylene coating
- ⑧ Painting
Baked finish of acrylic resin or melamine resin

Brake Mechanism of Reversible Motors

A reversible motor has a built-in friction brake mechanism (friction brake) at its rear. This mechanism is provided for the following purposes:

- To improve the instant reversing characteristics by adding a friction load
- To reduce overrun

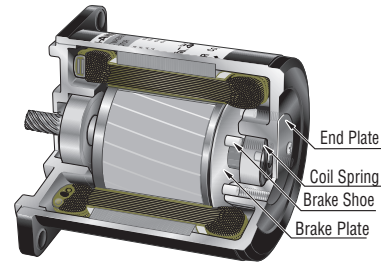

The brake mechanism is constructed as shown in the figure above. The coil spring applies constant pressure to allow the brake shoe to slide toward the brake plate.

This mechanism provides a certain degree of holding brake force, but the force is limited due to the mechanism's structure, as described above. The brake force produced by the brake mechanism of a reversible motor is approximately 10% of the motor's output torque.

Structure of an Electromagnetic Brake

An electromagnetic brake motor is equipped with a power off activated type electromagnetic brake.

As shown in the figure, when voltage is applied to the magnet coil, the armature is attracted to the electromagnet against the force of the spring, thereby releasing the brake and allowing the motor shaft to rotate freely.

When no voltage is applied, the spring works to press the armature onto the brake hub and hold the motor's shaft in place, thereby actuating the brake.

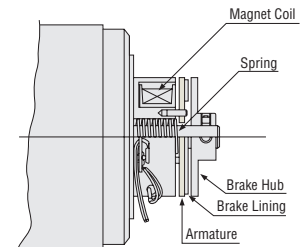

Structure and Operation of C·B Motor

The illustration to the right shows the structure of the **C·B** motor. When 24 VDC is not applied to either the clutch coil or brake coil, the output shaft can be rotated freely.



● Operation

When 24 VDC is applied to the clutch coil, the armature of the clutch coil is drawn against the clutch disk, transmitting motor rotation to the output shaft. The motor continues to rotate.

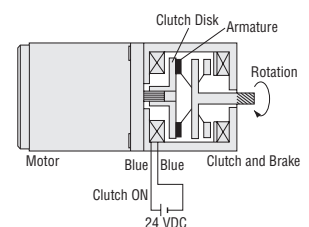

● Stopping and Load Holding

By turning the clutch coil excitation off after a certain time lag, applying 24 VDC to the brake coil will cause the armature on the brake to come into contact with the brake disk, which will cause the output shaft to come to a stop. During braking, the output shaft is released from the motor, so the inertia from the motor has no effect. The motor is constantly rotating.

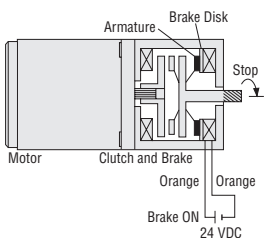

The figure below shows the relationship between the action of the motor shaft and output shaft and the state of excitation of the clutch and brake coils.

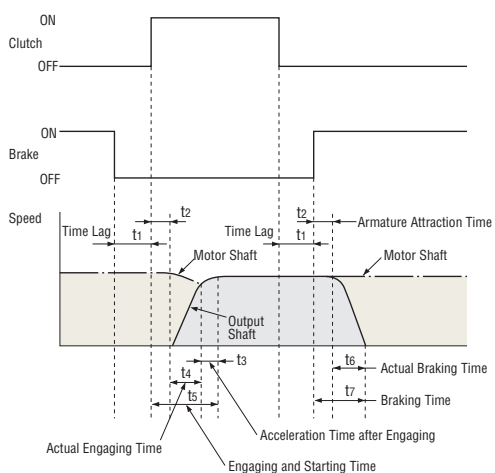

● Operation

When operation is shifted from holding the load to moving the load, a time lag of 20 ms or more is required after releasing the brake and before applying voltage to the clutch. (This is to prevent the clutch and brake from engaging at the same time.)

The time required for the clutch/brake output shaft to reach a constant speed after applying voltage to the clutch is referred to as the engaging and starting time (t_s) and is calculated by adding up the following time elements:

① Armature Attraction Time t_2

The time required for the armature to come into contact with the clutch after voltage application to the clutch.

② Actual Engaging Time t_4

The time required for the clutch/brake output shaft, which is accelerated by dynamic friction torque, to engage completely with the motor shaft after the armature comes in contact with the clutch.

③ Acceleration Time after Engaging t_3

The time needed to accelerate to the required speed when load is suddenly applied to the motor during actual engaging time described in ②, causing a temporary drop in speed.

● Braking

When operation is shifted from rotation to stopping or holding a load, a time lag of 20 ms or more is required after releasing the clutch and before applying voltage to the brake. The time required for the clutch/brake output shaft to come to a stop after applying voltage to the brake is referred to as the braking time (t_r) and is calculated by adding up the following time elements:

① Armature Attraction Time t_2

The time required for the armature to contact with the brake plate after voltage application to the brake.

② Actual Braking Time t_6

The time required for rotation of the clutch/brake output shaft to come to a stop after the armature comes into contact with the brake plate.

● Engaging and Starting Characteristics (Reference value)

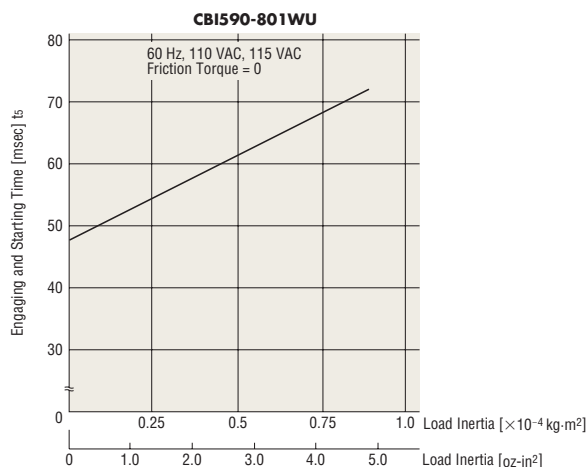

● Braking Characteristics (Reference value)

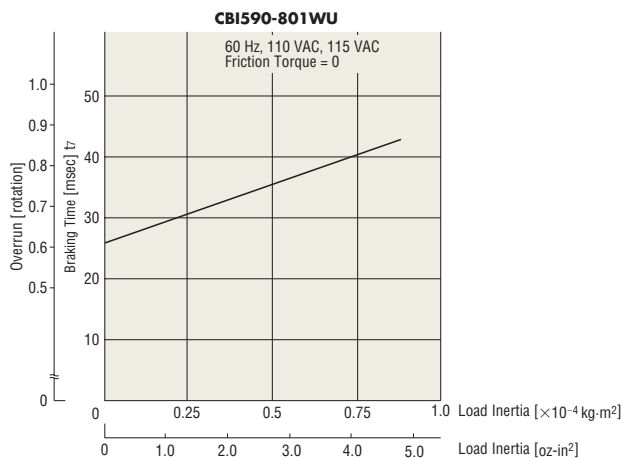

Speed – Torque Characteristics of Induction Motors

The figure below shows the speed – torque characteristics of induction motors.

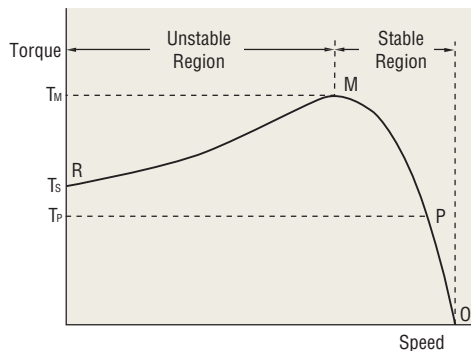

Under no load, the motor rotates at a speed close to synchronous speed. As the load increases, the motor's speed drops to a level (P) where a balance is achieved between load and motor torque (T_P). If the load is further increased and reaches point M, the motor can generate no greater torque and stops at point R. In other words, the motor can be operated in a stable range between M and O, while the range between R and M is subject to instability.

Induction motors are available in two types: single-phase (capacitor run) and three-phase induction motors. With the single-phase motor, the starting torque is generally smaller than the operating torque, while the three-phase motor features a relatively greater starting torque.

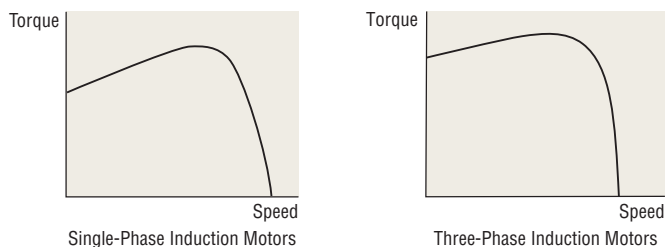

The torque the motor produces changes proportionally to roughly twice the power supply voltage. For example, if 110 V is applied to a motor whose rated voltage is 100 V, the torque produced by the motor increases to approximately 120%. In this case, the motor temperature will rise and may exceed the permissible range. If 90 V is applied to the same motor, the torque produced by the motor decreases to approximately 80%. In this case, the motor may not be able to operate the automated equipment as expected. For the above reasons, the power supply voltage should be kept within $\pm 10\%$ of the rated voltage. Otherwise, when the power supply voltage fluctuates beyond the aforementioned range, the motor temperature may rise beyond the permissible range or the motor torque may drop and thereby make the equipment operation unstable.

Speed – Torque Characteristics of Reversible Motors

The reversible motor is a capacitor run, single-phase induction motor that features the same speed – torque characteristics as an induction motor, as described above. However, the reversible motor features a higher starting torque than an induction motor in order to improve the instant reversing characteristics.

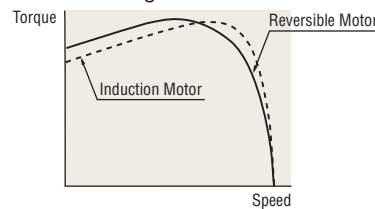

Speed – Torque Characteristics of Torque Motors

The figure below shows the speed – torque characteristics of torque motors. The speed – torque characteristics of torque motors differ from those of induction motors or reversible motors. As the graph shows, they have sloping characteristics (torque is highest at zero speed and decreases steadily with increasing speed), enabling stable operation over a wide speed range, from starting to no load speed. The torque generated during reversal of the motor is a large positive torque in the same direction as the rotational magnetic field. When the motor which rotates uni-directionally is locked by the load and the motor is rotated opposite the desired direction, this torque acts as a force (braking force) to inhibit the motor from rotating backwards.

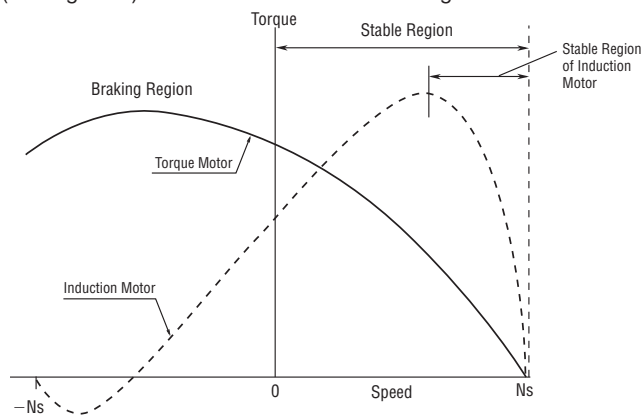

Temperature Rise in Standard AC Motors

Temperature Rise in Motors

When a motor is operating, all energy loss (copper loss, iron loss, etc.) of the motor is transformed into heat, causing the motor's temperature to rise.

- Induction motors (continuous rating) reach the saturation point of temperature rise after two or three hours of operation, whereupon its temperature stabilizes.
- Reversible motors (30 minutes rating) reach their limit for temperature rise after 30 minutes of operation. The temperature will increase further if operation continues.

● Measuring the Temperature Rise

The following is a description of the methods Oriental Motor uses for temperature measurement and for the determination of a motor's maximum permissible temperature rise.

◇ Thermometer Method

The temperature at which the temperature rise during motor operation becomes saturated is measured using a thermometer or thermocouple attached to the center of the motor case. The temperature rise is defined as the difference between the ambient temperature and measured temperature.

◇ Resistance Change Method

In the resistance change method, the winding temperature is measured according to the change in resistance value. A resistance meter and thermostat is used to measure the motor's winding resistance and ambient temperature before and after operation, from which the temperature rise in the motor windings is obtained.

■ Operating Time and Temperature Rise of Reversible Motors

Reversible motors have a "30 minute rating." However, the operating time varies according to the operating conditions, even with intermittent operation for short times. When using a reversible motor intermittently for a short period of time, a large current flows, which causes the generation of a large amount of heat when starting or reversing. However, as the natural cooling effect of the motor is high when the motor is left stopped for a longer period of time, you can curb rises in temperature.

The motor case temperature equals the rise in motor temperature plus the ambient temperature. Generally, if the case temperature of the motor is 90°C (194°F) or less, continuous motor operation is possible with the same operating conditions, considering the insulation class of motor winding. However, the lower the motor temperature is, the longer the bearing grease life is.

The motor temperature varies according to conditions such as the load, the operating cycle, the mounting method of the motor and the ambient temperature.

■ Overheat Protection Device

If a motor operating in run mode locks due to overload, ambient temperature rises rapidly, or the input current increases for some reason, the motor's temperature rises abruptly. If the motor is left in this state, the performance of the insulation within the motor may deteriorate, reducing its life and, in extreme cases, scorching the winding and causing a fire. In order to protect the motor from such thermal abnormalities, our motors recognized by UL and CSA Standards and conform to EN and IEC Standards are equipped with the following overheat protection device.

● Thermally Protected Motors

Motors with a frame size of 70 mm (2.76 in.) sq., 80 mm (3.15 in.) sq., 90 mm (3.54 in.) sq., or 104 mm (4.09 in.) sq. contain a built-in automatic return type thermal protector. The structure of a thermal protector is shown in the figure below.

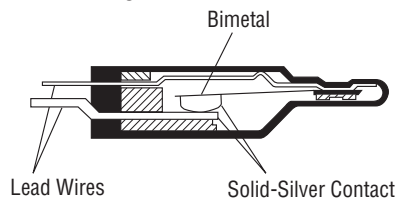

Structure of Thermal Protector

The thermal protectors employ bimetal contacts, with solid silver used in the contacts. Solid silver has the lowest electrical resistance of all materials, along with a thermal conductivity second only to copper.

◇ Operating Temperature of Thermal Protector

- Open...130±5°C (266±9°F)
(the operating temperature varies depending on the model)
- Close...82±15°C (179.6±27°F)
(the operating temperature varies depending on the model)

The motor winding temperature, where the thermal protector is activated, is slightly higher than the operating temperature listed above.

● Impedance Protected Motors

Motors with a frame size of 60 mm (2.36 in.) sq. or less are equipped with impedance protection.

Impedance protected motors are designed with higher impedance in the motor windings so that even if the motor locks, the increase in current (input) will be minimized and temperature will not rise above a certain level.

■ Capacitor

Oriental Motor's single-phase AC motors are all permanent split capacitor types. Permanent split capacitor motors contain an auxiliary winding offset by 90 electrical degrees from the main winding. The capacitor is connected in series with the auxiliary winding, causing the advance of current phase in the auxiliary winding.

Motors employ vapor-deposition electrode capacitors recognized by UL. This type of capacitor, which uses a metallized paper or plastic film as an element, is also known as a "self-healing (SH) capacitor" because of the self-healing property of the capacitor element. Although most of the previous capacitors used paper elements, the plastic film capacitor has become a mainstream model in recent years due to the growing demand for compact design.

● Capacitance

The use of a capacitor with a different capacitance may cause excessive motor vibration and heat generation or may result in torque drops and unstable operation. Be sure to use the capacitor included with the motor. The capacitor's capacitance is expressed in microfarads (μF).

● Rated Voltage

Using a capacitor exceeding the rated voltage may cause damage and then smoke or ignite. Be sure to use the capacitor included with the motor. The rated voltage of the capacitor is expressed in volts (V). The capacitor's rated voltage is indicated on the surface of the capacitor case. Take proper precautions, since the capacitor's rated voltage is different from that of the motor.

- Motors
- Linear and Rotary Actuators
- Selection Calculations
- Cooling Fans
- Service Life
- Stepping Motors
- Servo Motors
- Standard AC Motors
- Brushless Motors/AC Speed Control Motors
- Gearheads
- Linear and Rotary Actuators
- Cooling Fans

● Rated Conduction Time

The rated conduction time is the minimum design life of the capacitor when operated at the rated load, rated voltage, rated temperature and rated frequency. The standard life expectancy is 25000 hours. A capacitor that breaks at the end of its life expectancy may smoke or ignite. We recommend that the capacitor be replaced after the rated conduction time. Consider providing a separate protection measure to prevent the equipment from being negatively influenced in the event of capacitor failure.

● Safety Feature of Capacitor

Some capacitors are equipped with a safety feature that allows for safe and complete removal of the capacitor from circuits to prevent smoke and/or fire in the event of a dielectric breakdown. Oriental Motor products use capacitors with UL recognized safety features that have passed the UL 810 requirement of the 10000 A fault current test.

■ Glossary

● Ratings

◇ Ratings

Motor ratings represent the operation limit certified on dynamic characteristics such as temperature, mechanical strength, vibration and efficiency. There are two categories, continuous rating and limited duty rating. Operation limit on output power, as well as voltage, frequency and speed are established. These are known as rated output power, rated voltage, rated frequency and rated speed, respectively.

◇ Continuous and Limited Duty Ratings

The time during which output can continue without abnormality is called a time rating. When continuous operation at rated output is possible, it is known as a continuous rating. When operation at rated output is possible only for a limited time, it is known as the limited duty rating.

● Output Power

◇ Output Power

The amount of work that can be performed in a given period of time is determined by the motor's speed and torque. Each motor specification indicates the value of rated output power. Output power is expressed in watts or in horsepower.

$$\text{Output Power [Watts]} = 1.047 \times 10^{-1} \times T \times N$$

1 HP = 746 Watts

where: 1.047×10^{-1} : Constant

T [N·m] : Torque

N [r/min] : Speed

◇ Rated Output Power

This term refers to output power generated continuously when the optimal characteristics are achieved at the rated voltage and frequency in continuous operation. The speed and torque that produce the rated output power are called the rated speed and rated torque. Generally, the term "output power" refers to rated output power.

● Torque

◇ Starting Torque

This is the torque generated instantly when the motor starts. If the motor is subjected to a friction load greater than this torque, it will not operate. See ① in the figure on the right.

◇ Stall Torque

This is the maximum torque under which the motor will operate at a given voltage and frequency. If a load greater than this torque is applied to the motor, it will stall. See ② in the figure below.

◇ Rated Torque

This is the torque generated when the motor is continuously producing rated output power at the rated voltage and frequency. It is the torque at rated speed. See ③ in the figure below.

◇ Static Friction Torque

Static friction torque is the torque output required to hold a load when the motor is stopped by an electromagnetic brake or similar device.

◇ Permissible Torque

The permissible torque is the maximum torque that can be used when the motor is running. It is limited by the motor's rated torque, temperature rise and the strength of the gearhead combined with the motor.

Speed – Torque Characteristics

①: Starting torque

②: Stall torque

③: Rated torque

④: Synchronous speed

⑤: No load speed

⑥: Rated speed

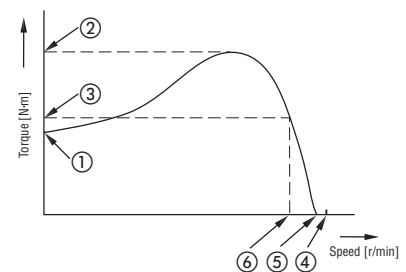

● Speed

◇ Synchronous Speed

This is an intrinsic factor determined by line frequency and the number of poles.

It is indicated as the speed per minute.

$$N_s = \frac{120f}{P} \text{ [r/min]}$$

N_s : Synchronous speed [r/min]

f : Frequency [Hz]

P : Number of poles

120 : Constant

For example, for a four-pole motor with a line frequency of 60 Hz the synchronous speed will be:

$$N_s = \frac{120 \times 60}{4} = 1800 \text{ [r/min]}$$

See ④ in the figure above.

◇ No Load Speed

This is the speed under no load conditions.

The speed of induction or reversible motors under no load conditions is lower than synchronous speed by a few percent (approximately 20 to 60 r/min). See ⑤ in the figure above.

◇ Rated Speed

This is the appropriate speed of the motor at rated output power.

From the standpoint of utility, it is the most desirable speed.

See ⑥ in the figure above.

◇ Slip

The following formula is one method of expressing speed:

$$S = \frac{N_s - N}{N_s} \quad \text{or} \quad N = N_s (1 - S)$$

N_s : Synchronous speed [r/min]

N : Speed under a given load [r/min]

In the case of a four-pole, 60 Hz induction motor operated with a slip of $S = 0.1$, the speed under a given load will be:

$$N = \frac{120 \times 60}{4} (1 - 0.1) = 1800 (1 - 0.1) = 1620 \text{ [r/min]}$$

● Overrun

◇ Overrun

This is the number of excess rotations the motor makes from the instant the power is cut off to the time that it actually stops. It is normally indicated either by angle or by rotations.

● Gearhead

◇ Gear Ratio

The gear ratio is the ratio by which the gearhead reduces the motor speed. The speed at the gearhead's output shaft is $\frac{1}{\text{Gear Ratio}}$ times the motor speed.

◇ Maximum Permissible Torque

This is the maximum load torque that can be applied to the gearhead.

It is dependent upon such mechanical strength factors as the materials of gearheads and bearings, and size. Therefore, it varies according to the gearhead type and gear ratio.

◇ Service Factor

This is a coefficient used to estimate the gearhead life.

These values are determined in accordance with the results of life tests under various loads and conditions of use.

◇ Transmission Efficiency

This is the efficiency when the torque is transmitted with the gearhead combined.

It is expressed as a percentage (%) and is determined by the friction in the gears and bearings used in the gearhead and the resistance of the lubrication grease.

Transmission efficiency is, when using a **GN** gearhead, usually 90% for one stage of reduction gears and is 81% for two stage gearheads. As the gear ratio increases, the number of reduction gear stages increases, with a consequent reduction in the gear efficiency to 73% and 66% for each gear stage added.

◇ Overhung Load

This is a load on the gearhead output shaft in the vertical direction.

The maximum overhung load on a gearhead shaft is called the permissible overhung load and it varies with the gearhead type and distance from the shaft end.

This is equivalent to tension under belt drive.

◇ Thrust Load

This is the load that is placed in the direction of the gearhead output shaft.

The maximum thrust load on the gearhead is called the permissible thrust load, which varies with the gearhead type.

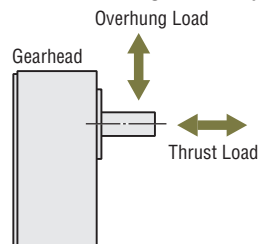

● Others

◇ CW, CCW

These show the direction of motor rotation.

CW is clockwise as seen from the output shaft, while CCW is counterclockwise.

Motors	Selection Calculations
Linear and Rotary Actuators	Cooling Fans
Stepping Motors	Service Life
Servo Motors	Standard AC Motors
Brushless Motors/AC Speed Control Motors	Gearheads
	Linear and Rotary Actuators
	Cooling Fans

Brushless Motors/AC Speed Control Motors

Brushless Motor Structure and Principle of Operation

Structure of Brushless Motor

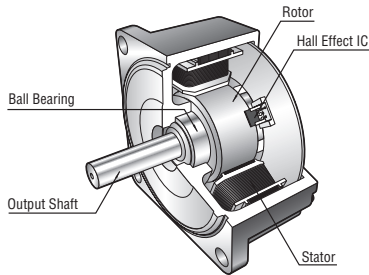

The brushless motor has a built-in magnetic element or optical encoder for the detection of rotor position. The position sensors send signals to the drive circuit. The brushless motor uses three-phase windings in a "star" connection. A permanent magnet is used in the rotor.

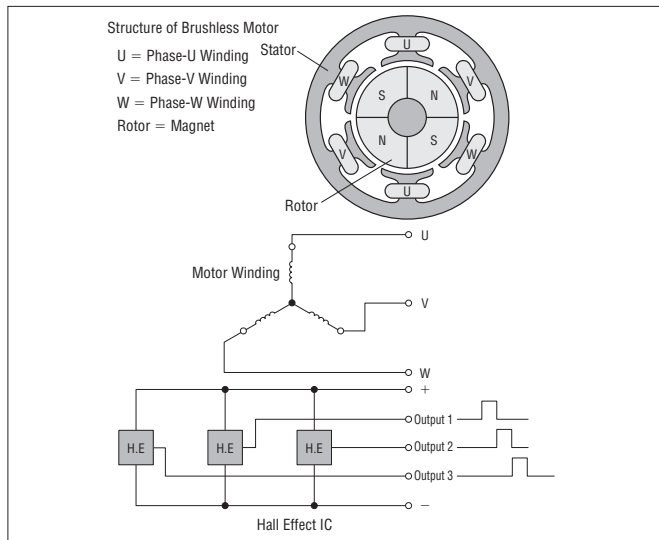

A Hall effect IC is used for the sensor's magnetic element. Three Hall Effect ICs are placed within the stator and send digital signals as the motor rotates.

Drive Method of Brushless Motors

The motor windings are connected to switching transistors, six of which make up the inverter. The top and bottom transistors turn on and off according to a predetermined sequence to change the direction of current flow in the windings. The mechanism of brushless motor rotation can be described as follows:

In step 1 of the transistor's switching sequence, as shown in the following figure, transistors Tr1 and Tr6 are in the "ON" state. At this time the winding current flows from phase U to phase W, and excites U and W respectively, thus causing the rotor to turn 30°. Repeating such a motion 12 times thereby facilitates rotation of the motor.

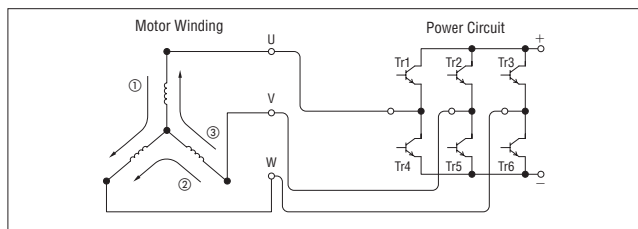

Switching Sequences of Individual Transistors

Step	①	②	③	④	⑤	⑥	⑦	⑧	⑨	⑩	⑪	⑫	⑬
Tr1	ON					ON	ON						ON
Tr2		ON	ON					ON	ON				
Tr3				ON	ON					ON	ON		
Tr4			ON	ON				ON	ON				
Tr5					ON	ON					ON	ON	
Tr6	ON	ON					ON	ON					ON
Phase-U	N	-	S	S	-	N	N	-	S	S	-	N	N
Phase-V	-	N	N	-	S	S	-	N	N	-	S	S	-
Phase-W	S	S	-	N	N	-	S	S	-	N	N	-	S

Control Method of Brushless Motors

The drive circuit of the brushless motor is connected in the configuration shown in the figure below and is comprised of five main blocks.

- Power circuit
- Current control circuit
- Logic circuit
- Setting comparison circuit
- Power supply circuit

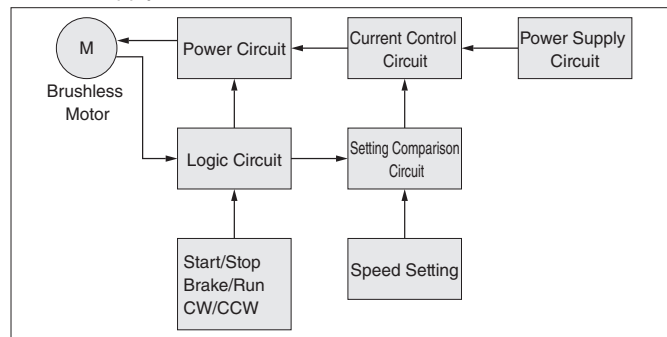

◇ Power Circuit

This circuit uses six transistors to control the current flow in the motor windings.

The transistors provided at the top and bottom turn on and off repeatedly according to a predetermined sequence, thereby controlling the current flow to the motor windings.

◇ Current Control Circuit

The current flow to the motor varies according to the load. It is constantly detected and controlled so that the speed will not deviate from the set speed.

◇ Logic Circuit

The logic circuit detects the rotor position by receiving feedback signals from the motor's Hall Effect IC and determines the excitation sequence of motor windings. The circuit signal is connected to each transistor base in the power circuit, driving the transistors according to a predetermined sequence. It also detects the motor's speed. The logic circuit is also used to control commands to the motor, including start/stop, brake/run and CW/CCW.

◇ Setting Comparison Circuit

This circuit compares the motor speed signal against the speed setting signal in order to determine whether the motor speed is higher or lower than the set speed. The input to the motor is lowered if the motor speed is higher than the set speed, but the input is raised if it is lower than the set speed. In this manner, the speed that has varied is returned to the set speed.

◇ Power Supply Circuit

This circuit converts a commercial power supply into the voltage necessary to drive the motor and control circuits.

Speed Control Methods of AC Speed Control Motors

The basic block diagrams and outline of the control methods are shown below. AC speed control motors employ a closed-loop control system, while inverters employ an open-loop control system.

● Inverters

◇ BHF Series, FE100/FE200

Control Method

- ① Input from the AC power supply is rectified, and output as DC voltage.
- ② A voltage signal led by the frequency set with the potentiometer for setting frequency is output.
- ③ Voltage of the set frequency is applied to the motor.

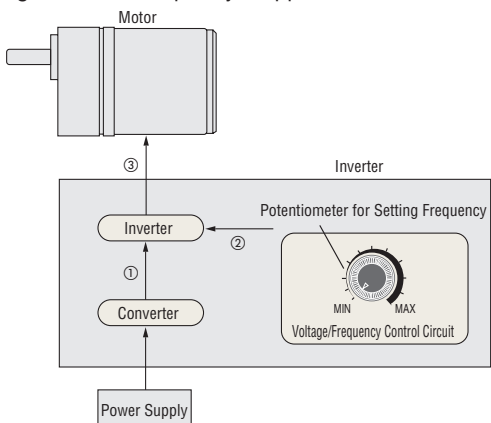

● AC Speed Control Motors

◇ ES01/ES02, US Series

Control Method

- ① The speed setting voltage is supplied via a speed potentiometer.
- ② The motor speed is detected and the speed signal voltage is supplied.
- ③ The difference between the speed setting voltage and speed signal voltage is output.
- ④ A voltage determined by the output from the comparator is supplied to the motor so that it will reach the set speed.

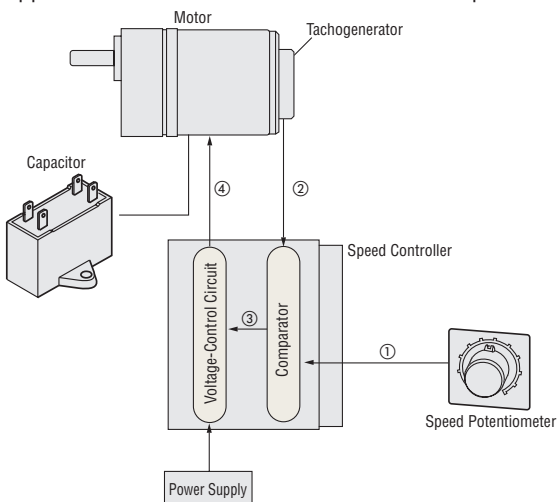

Speed – Torque Characteristics of Brushless Motors and AC Speed Control Motors

● Brushless Motors

The figure below illustrates the speed – torque characteristics example of a **BLF** Series motor. Other motors also have similar characteristics, although their speed control ranges are different. Brushless motors generate constant rated torque from 80 to 4000 r/min, with the same starting torque as rated torque. (With the **BLF** Series, **BLE** Series and **BLH** Series, the output torque at the maximum speed is less than rated torque.) Unlike AC speed control motors, torque in a brushless motor will not drop at low speeds, so brushless motors can be used at rated torque from high to low speeds.

In addition to continuous duty region, brushless motors also have limited duty region. The torque generated in the limited duty region, which is 1.2 times the rated torque (2 times for the **BX** Series, **BLE** Series and **BLF** Series), is effective for starting inertial load. If operated for more than approximately five seconds in the limited duty region, the overload protective function of the driver may engage and the motor will coast to a stop.

Speed – Torque Characteristics

BLF460A-□
BLF460A-□**FR**
BLF460A-A

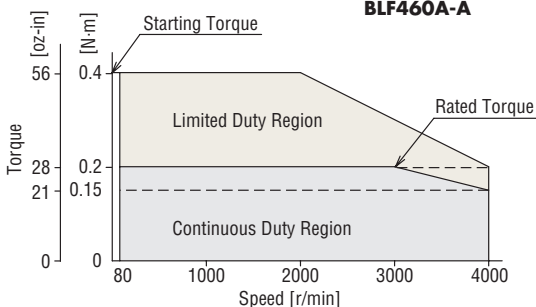

● Inverters

The speed – torque characteristics shown in the figure below are typical for all inverters.

The speed of an inverter varies depend on the frequency of the voltage applied to the motor. Accordingly, the speed also changes due to the load torque, which is equal to the induction motor.

Speed – Torque Characteristics **FE100C/5IK40GN (A)-SW2**

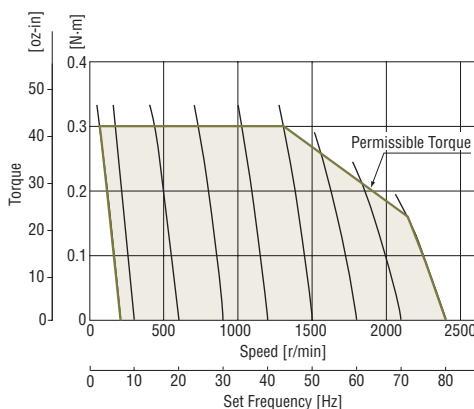

● AC Speed Control Motors

The speed – torque characteristics shown in the figure below are typical for all AC speed control motors.

Speed – Torque Characteristics **ES01/5IK40RGN(A)-AW2U**

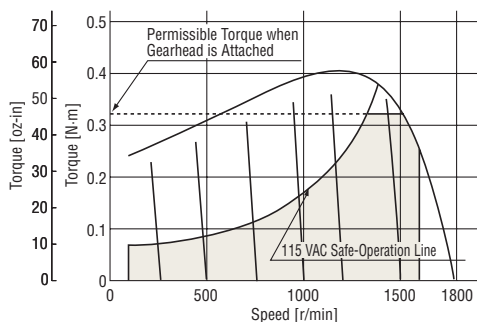

● Safe-Operation Line and Permissible Torque When a Gearhead is Attached

Input power to the speed control motor varies with the load and speed. The greater the load and the lower the speed, the greater an increase in motor temperature.

In the speed – torque characteristics of an AC speed control motor and inverter, there is the safe-operation line, while the area below the line is called the continuous duty region.

The safe-operation line, measured by the motor's temperature, indicates its limit for continuous operation (Reversible motor: As long as the temperature level remains below the permissible maximum temperature rating, a reversible motor can be operated continuously. If not, 30 minute operation is required.)

Whether the motor can be operated at a specific load and speed is determined by measuring the temperature of the motor case. In general, when the motor case temperature is 90°C (194°F) or less, continuous operation is possible, depending on the insulation class of motor winding. It is recommended that the motor be used under conditions that keep the motor temperature low, since the motor life is extended with a lower motor temperature.

When using a gearhead, be aware that it is necessary to operate below the torque in the "gearmotor – torque table." If the actual torque required exceeds this torque, it may damage the gearhead and shorten its life.

● Variable Speed Range (Speed ratio) and Load Factor

When the ratio of minimum speed and maximum speed of an AC speed control motor is given as the motor's speed ratio, the speed ratio increases to as much as 20:1 in a range where the load factor (ratio of load torque to starting torque) is small (refer to the 20% load factor range in the diagram to the right). This widens the motor's range of operation.

If the load factor is high, the speed ratio becomes low.

◇ Load Factor and Speed Ratio

The following explains the relationship of load factor and speed ratio. A motor is used in combination with a gearhead. The following assumes such a configuration.

The following table shows the continuous duty region and speed ratio of the **US** Series at load factors of 20% and 50%, as read from the diagram.

Although the speed ratio is large when the load factor is 20%, it decreases when the load factor is 50%. As shown, generally AC speed control motors do not have a wide speed range. To operate your motor over a wide speed range, choose a type that offers high starting torque (a motor with the next larger frame size).

With a brushless motor, the operation speed range remains wide regardless of the load factor, as indicated by the dotted line.

Speed – Torque Characteristics **US590-501U2/5GU5KA**

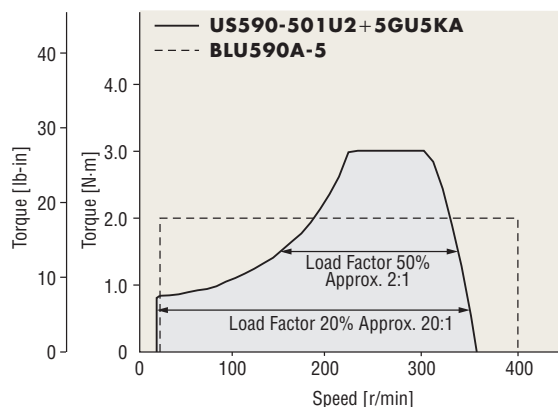

Load Factor [%]	Continuous Duty Region		Speed Ratio
	Min. Speed [r/min]	Max. Speed [r/min]	
20	17	348	Approx. 20:1
50	148	337	Approx. 2:1

◇ Speed Ratio When a High Ratio Gearhead is Used

Since the starting torque is also limited by the maximum permissible torque of the gearhead, the load factor of a gearhead with a high gear ratio is determined by the load torque with respect to the maximum permissible torque of the gearhead.

In the previous example, a gearhead with a gear ratio of 5:1 was used. The diagram below shows when a gearhead with a gear ratio of 100:1 is used.

Speed – Torque Characteristics with a High Gear Ratio

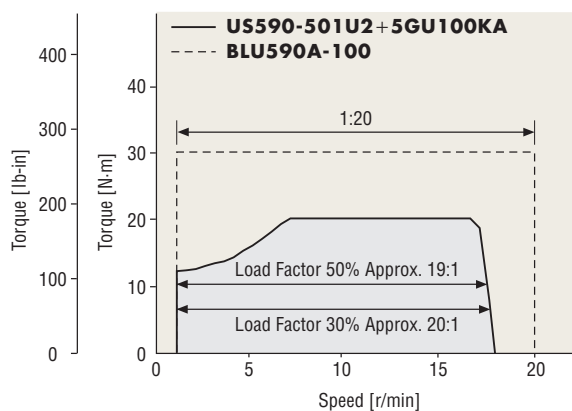

The maximum permissible torque of the **5GU100KA**, which has a gear ratio of 100:1, is 20 N·m (177 lb-in). The speed ratios at load factors of 30% and 50% are shown in the table below:

Load Factor [%]	Continuous Duty Region		Speed Ratio
	Min. Speed [r/min]	Max. Speed [r/min]	
30	0.9	17.6	Approx. 20:1
50	0.9	17.4	Approx. 19:1

The table above demonstrates that high speed ratios can be obtained by combining a motor with a gearhead having a high gear ratio, in which case the load factor is one of minor concern.

Load Torque – Driver Input Current Characteristics of Brushless Motors (Reference values)

The driver input current for brushless motors varies with the load torque. Load torque is roughly proportional to the driver input current. These characteristics may be used to estimate load torque from the driver input current. However, this is valid only when the motor is rotating at a steady speed. Starting and bi-directional rotation requires greater current input so the characteristics do not apply to such operations.

● Data for combination types models and geared motors apply to the motor only.

◇ BX Series

BX230A□-□S, **BX230A**□-□FR,

BX230A□-A

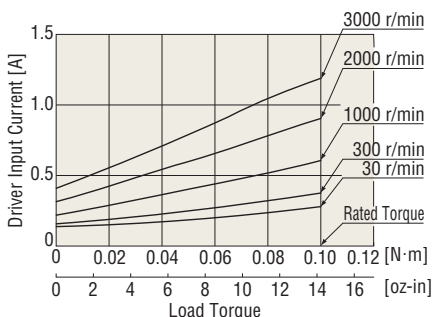

BX230C□-□S, **BX230C**□-□FR,

BX230C□-A (Single-phase 200-230 VAC)

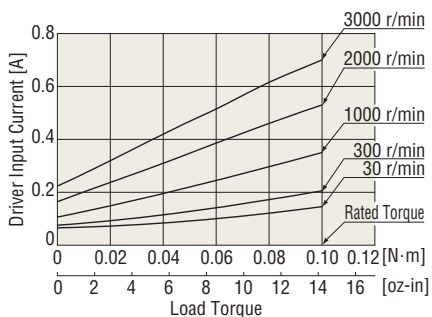

BX230C□-□S, **BX230C**□-□FR,

BX230C□-A (Three-phase 200-230 VAC)

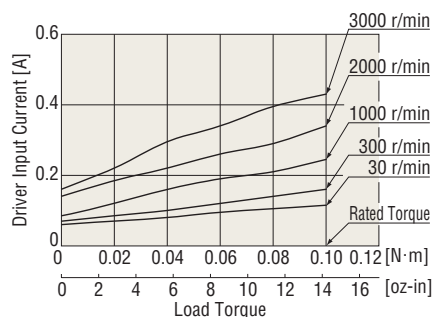

BX460A□-□S, **BX460A**□-□FR,

BX460A□-A

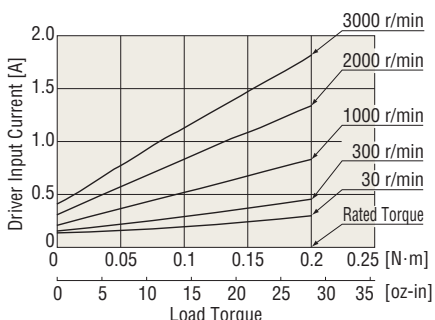

BX460C□-□S, **BX460C**□-□FR,

BX460C□-A (Single-phase 200-230 VAC)

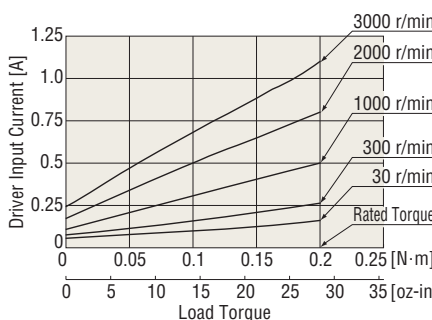

BX460C□-□S, **BX460C**□-□FR,

BX460C□-A (Three-phase 200-230 VAC)

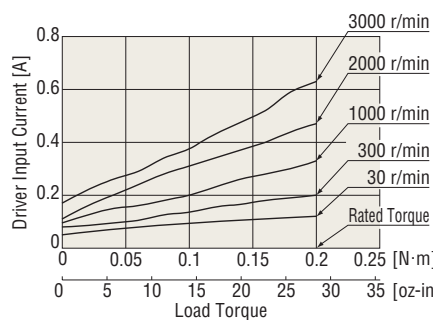

BX5120A□-□S, **BX5120A**□-□FR,

BX5120A□-A

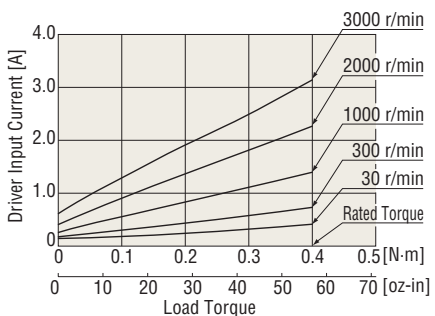

BX5120C□-□S, **BX5120C**□-□FR,

BX5120C□-A (Single-phase 200-230 VAC)

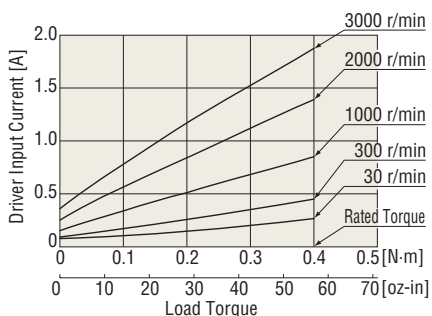

BX5120C□-□S, **BX5120C**□-□FR,

BX5120C□-A (Three-phase 200-230 VAC)

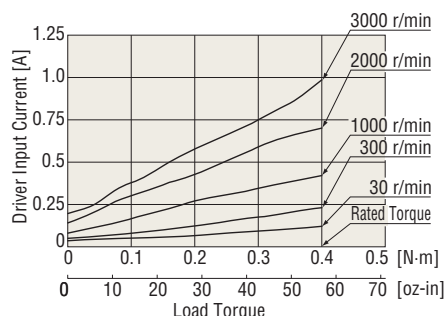

BX6200A□-□S, **BX6200A**□-□FR,

BX6200A□-A

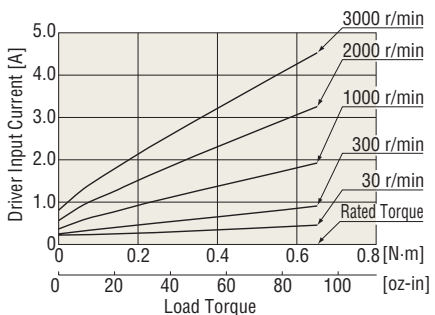

BX6200C□-□S, **BX6200C**□-□FR,

BX6200C□-A (Single-phase 200-230 VAC)

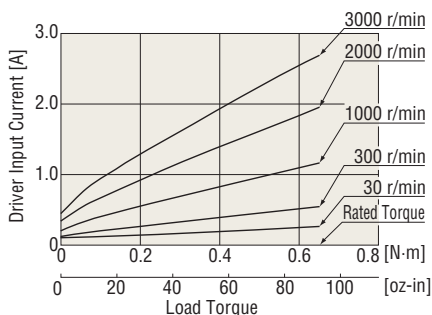

BX6200C□-□S, **BX6200C**□-□FR,

BX6200C□-A (Three-phase 200-230 VAC)

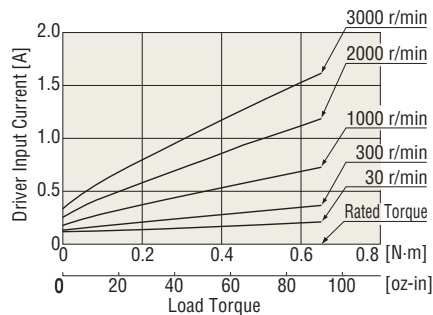

● In the event of electromagnetic brakes, "M" is entered in the □ box in the product name.
Enter the gear ratio in the box (□) within the model name.

Brushless Motors/AC Speed Control Motors

BX6400S S, **BX6400S** FR,
BX6400S A

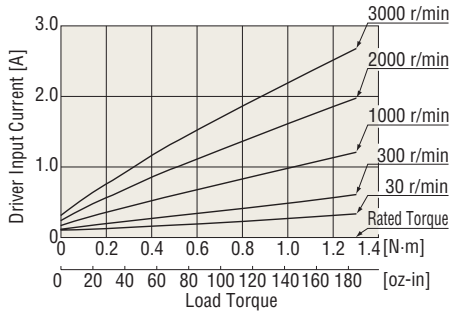

◇ BLE Series

BLE23A S, **BLE23A** F, **BLE23A** A

BLE23A S-3, **BLE23A** F-3, **BLE23A** A-3

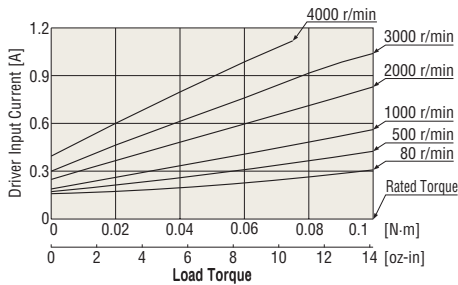

BLE23C S, **BLE23C** F, **BLE23C** A,

BLE23C S-3, **BLE23C** F-3, **BLE23C** A-3

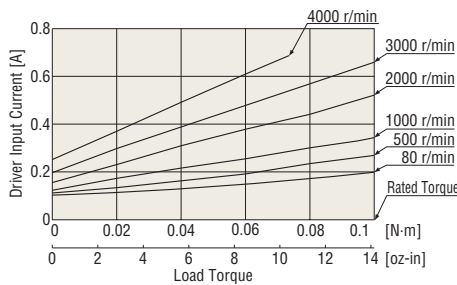

BLE23S S, **BLE23S** F, **BLE23S** A,

BLE23S S-3, **BLE23S** F-3, **BLE23S** A-3

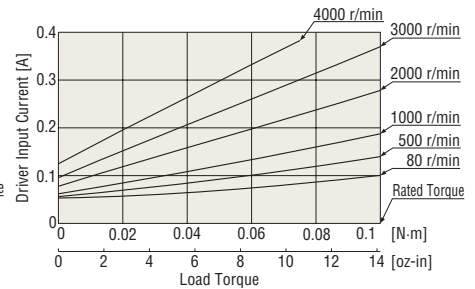

BLE46A S, **BLE46A** F, **BLE46A** A,

BLE46A S-3, **BLE46A** F-3, **BLE46A** A-3

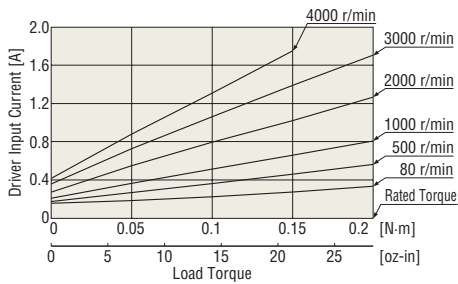

BLE46C S, **BLE46C** F, **BLE46C** A,

BLE46C S-3, **BLE46C** F-3, **BLE46C** A-3

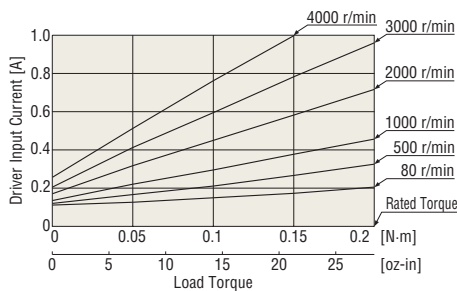

BLE46S S, **BLE46S** F, **BLE46S** A,

BLE46S S-3, **BLE46S** F-3, **BLE46S** A-3

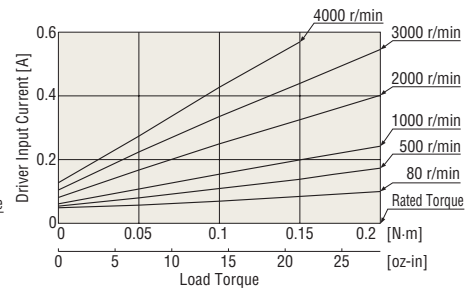

BLE512A S, **BLE512A** F, **BLE512A** A,

BLE512A S-3, **BLE512A** F-3, **BLE512A** A-3

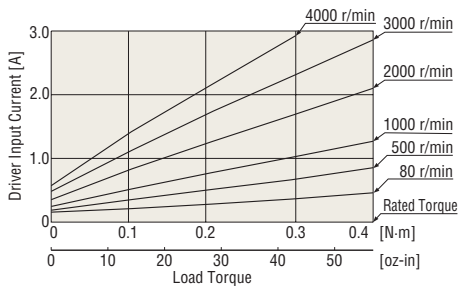

BLE512C S, **BLE512C** F, **BLE512C** A,

BLE512C S-3, **BLE512C** F-3, **BLE512C** A-3

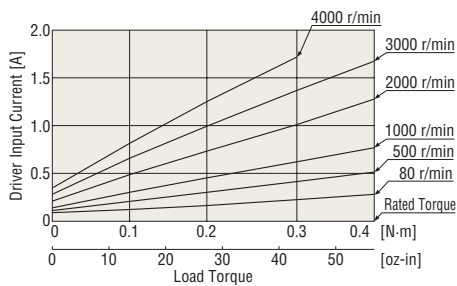

BLE512S S, **BLE512S** F, **BLE512S** A,

BLE512S S-3, **BLE512S** F-3, **BLE512S** A-3

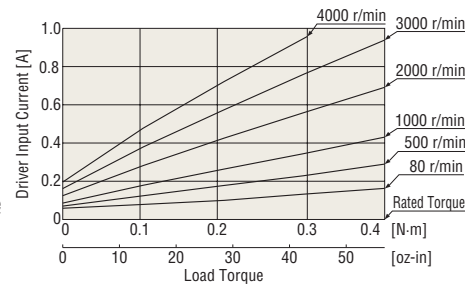

● In the event of electromagnetic brakes, "M" is entered in the box in the product name.
Enter the gear ratio in the box () within the model name.

◆ BLU Series

BLU220A-□, BLU220A-□FR
BLU220A-A

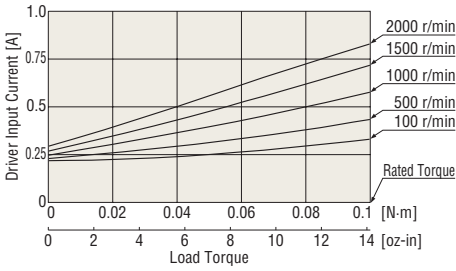

BLU220C-□, BLU220C-□FR
BLU220C-A

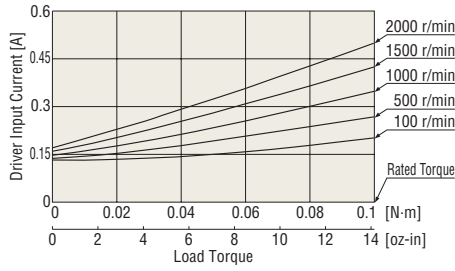

BLU220S-□, BLU220S-□FR
BLU220S-A

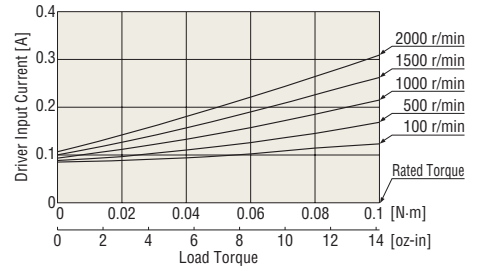

BLU440A-□, BLU440A-□FR
BLU440A-A

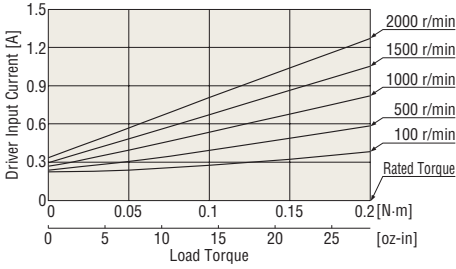

BLU440C-□, BLU440C-□FR
BLU440C-A

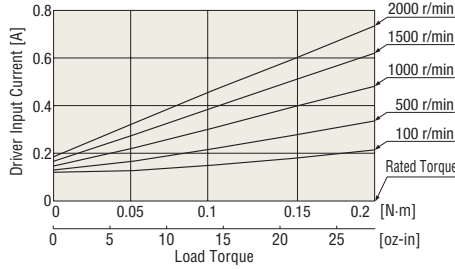

BLU440S-□, BLU440S-□FR
BLU440S-A

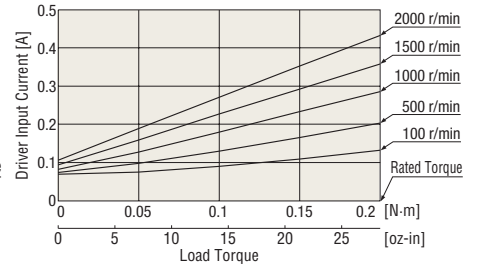

BLU590A-□, BLU590A-□FR
BLU590A-A

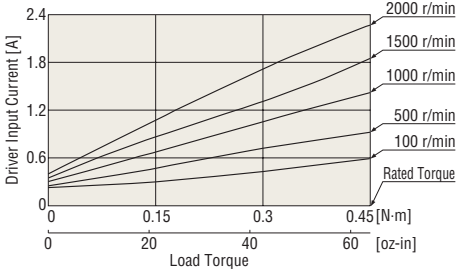

BLU590C-□, BLU590C-□FR
BLU590C-A

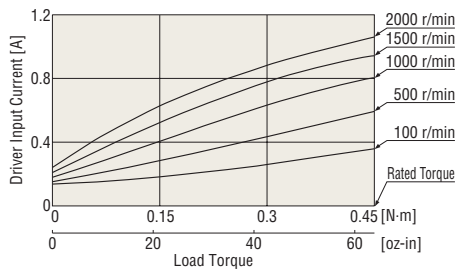

BLU590S-□, BLU590S-□FR
BLU590S-A

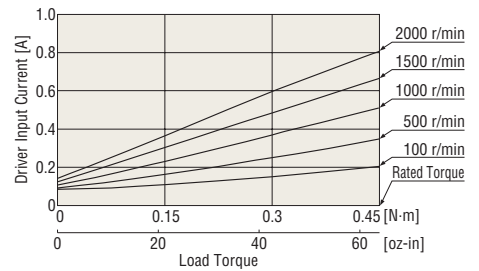

◆ BLH Series

BLH015K-□
BLH015K-A

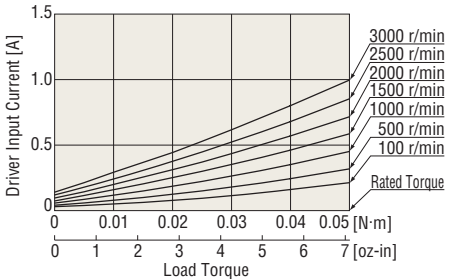

BLH230KC-□, BLH230KC-□FR
BLH230KC-A

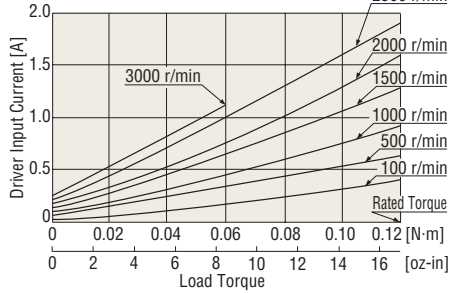

BLH450KC-□, BLH450KC-□FR
BLH450KC-A

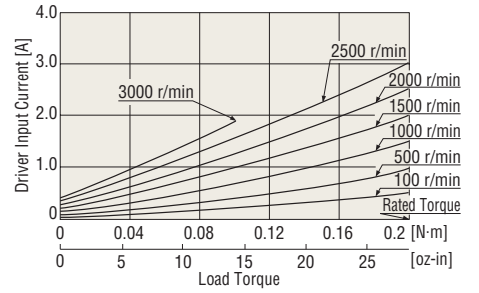

BLH5100KC-□, BLH5100KC-□FR
BLH5100KC-A

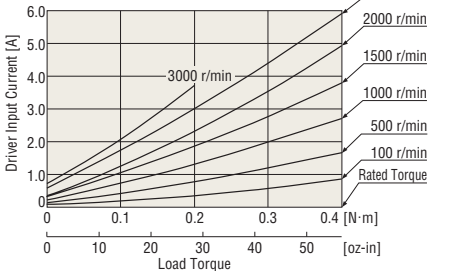

● Enter the gear ratio in the box (□) within the model name.

Gearheads

■ Role of the Gearhead

The role of a gearhead is closely related to motor development. Originally, when the AC motor was a simple rotating device, the gearhead was mainly used to change the motor speed and as a torque amplifier. With the introduction of motors incorporating speed control functions, the primary role of the gearhead was to amplify torque. But with the wide acceptance of stepping motors used to meet the requirements for control of speed and position, gearheads found new purposes, including the amplification of torque, improvement in permissible inertia and reduction of motor vibration. Furthermore, the accurate positioning capability of motors has created a demand for high-precision, backlash-free gearheads, unlike the conventional gearheads for AC motors. Oriental Motor, keeping up with these trends, has been developing specific gearheads having optimal characteristics needed to preserve the characteristics of the motor with which it is used. Gearheads for AC motors are designed with emphasis on high permissible torque, long life, low noise and a wide range of gear ratios to use continuously as a power source. By contrast, gearheads for stepping motors are designed for high accuracy positioning, where high accuracy, high permissible torque and high speed operation are important. The following sections describe these gearheads in detail.

■ Gearheads for AC Motors

Standard AC motors have a long history, as do the gearheads used with these motors. During the course of that history, AC motors and gearheads have found a wide spectrum of applications and user needs including low noise level, high power, long life, wide range of gear ratios and resistance to environmental conditions. Oriental Motor has developed products in order to accommodate various needs.

Following is a description of the major mechanical categories that apply to gearheads.

● Parallel Shaft Gearheads

Parallel shaft gearheads are the most commonly used gear systems today. Our parallel shaft gearheads employ spur gears and helical gears. Particularly, helical gears are used for low noise, high strength performance.

● Spur Gear

The spur gear is a cylindrical gear on which the teeth are cut parallel to the shaft.

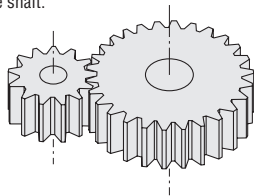

● Helical Gear

The helical gear is a cylindrical gear having teeth cut in a helical curve. Its high rate of contact, as compared to the spur gear, has the advantages of low noise and higher strength, but its axial load calls for careful consideration in design.

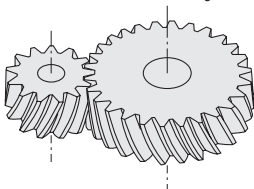

In both types of gearheads, the helical configuration is employed for the motor pinion and its mating gear. This contributes significantly to noise reduction because of their high contact speeds, thereby achieving lower noise output.

The long life, low noise **GN-S** gearhead and **GV** gearhead is illustrated in the following example.

The **GN-S** gearhead generates less noise than the conventional gearhead thanks to a rigid gear case and gears with a special shape and surface machining assembled with the use of advanced technology.

The **GN-S** gearhead and **GE-S** gearhead achieve a rated life of 10000 hours by adopting a large, specially designed bearing and reinforced gears.

GN-S Gearhead

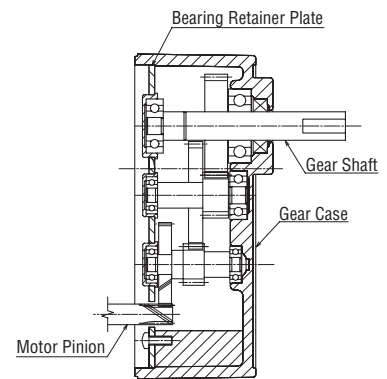

GN-S Gearhead

The **GV** gearhead achieves noise reduction through improving gear case rigidity, further improvement of gear machining technology, and higher accuracy in assembly technology. The **GV** gear head, with its hardened gears made by carburizing and quenching and the larger bearings also achieves permissible torque of two to three times that of conventional products, as well as a rated life of 10000 hours. Moreover, the **GV** gearhead will survive 20000 hours of operation when used under the same torque commonly expected of conventional gear heads. Indeed, the **GV** gearhead provides a great way to extend maintenance intervals and save energy and resources.

GV Gearhead

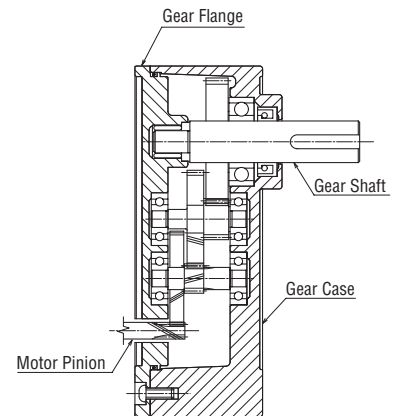

GV Gearhead

For use with standard AC motors, many of which are constant speed motors, the availability of various gear ratios suits a wide range of desired speeds. We support these motors with 20 different gear ratios, ranging from 3:1 to 180:1.

● Right-Angle Gearheads (Solid shaft and hollow shaft)

The right-angle gearhead is designed to facilitate the efficient use of limited mounting space and the elimination of couplings and other power-transmission components (in the case of the hollow shaft gearhead). Oriental Motor's gearheads consist of right-angle, hollow shaft gearheads and right-angle, solid shaft gearheads (**RH, RA**), which have worm gears, screw gears or hypoid gears [□104 mm (4.09 in.)]. Both right-angle gearheads incorporate right-angle gearing at the final stage, leaving the input end identical to that of the parallel shaft gearheads (**GN-S, GE-S, GU**). This facilitates the conversion from the parallel shaft gearhead to a right-angle gearhead without changing the motor.



Hollow Shaft Type



Solid Shaft Type

◇ Worm Gears

The worm gear transmits power from a single or multiple threaded worm to a mating worm wheel. The worm gear has a long history like the spur gear, but its application has been limited due to its relatively low efficiency and difficulty of manufacturing. Oriental Motor has successfully incorporated the worm gear based on its right-angle property and capacity for large gear ratios, and has improved its efficiency over conventional types by increasing the lead.

● Worm Gear

The worm gear transmits power from a single or multiple threaded worm to a mating worm wheel.

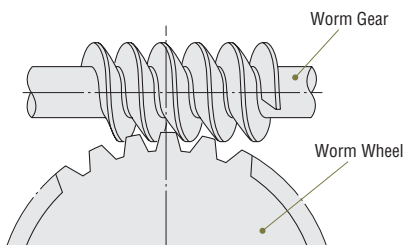

◇ Screw Gears

A single screw is like a regular helical gear. While the mating helical gears in the parallel shaft configuration have equal helix angles and contact with the helixes running in opposite directions, the screw gears are designed to contact their shafts crossing at right angles. Due to their point-to-point contact configuration, they're mainly used under relatively small loads, such as at low gear ratios with our right-angle gearheads.

● Screw Gear

The screw gear is helical gear used on offset shafts (neither perpendicular nor parallel to each other)

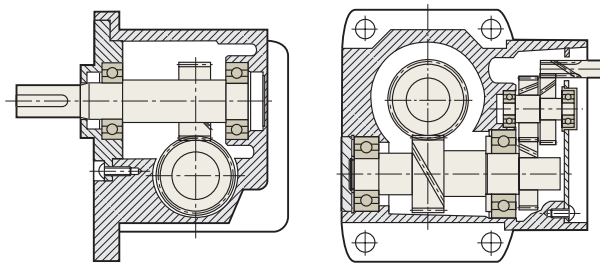
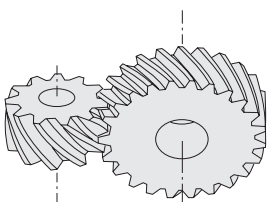

Structure of the Screw Gear in the Right-Angle Gearhead

◇ Hypoid Gears

Generally, the differential gears for automotive use have been hypoid gears. Being something of a midpoint between the 0 offset bevel gear and maximum-offset worm gear, the hypoid gear achieves a combination of high strength and efficiency. The offset placement of the pinion gear of the hypoid gear allows the suppression of vibration and helps obtain higher gear ratios, as compared to the bevel gear. The hypoid gears in Oriental Motor's gearheads are incorporated at the final stage, facilitating the disassembly of the gears from the motor.

● Offset: In hypoid gears the two shafts do not cross but are in displaced planes, separated from each other at a right angle. The displacement is called the offset.

● Hypoid Gear

The hypoid gear is conical gear with curved teeth for transmitting power between two offset shafts.

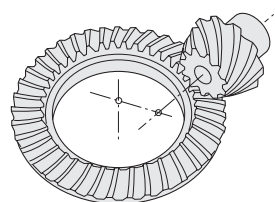

BH Series, Hypoid Gear

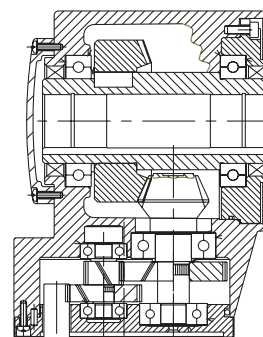
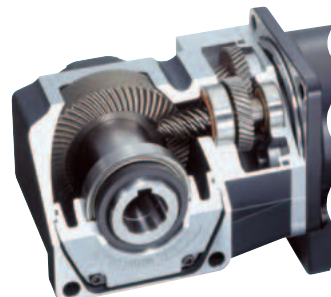

Structure of the Hypoid Gear

- Motors
- Linear and Rotary Actuators
- Selection Calculations
- Cooling Fans
- Service Life
- Stepping Motors
- Servo Motors
- Standard AC Motors
- Brushless Motors/AC Speed Control Motors
- Gearheads
- Linear and Rotary Actuators
- Cooling Fans

■ Gearheads for Brushless Motors

Brushless motors used for speed control have a high maximum speed in a range of 3000 to 4000 r/min. Accordingly, gearheads to be combined with these motors must keep the noise level low even at high speeds, while also ensuring high permissible torque and long life to fully utilize the characteristics of the high output motors. There are two types of gearheads for Oriental Motor's brushless motors. First is a parallel shaft type, similar to our AC motor gearheads and second, a hollow shaft flat gearheads, similar in construction but with a hollow shaft.

● Hollow Shaft Flat Gearheads

Hollow shaft flat gearheads need few connection parts such as couplings and also prevent saturation of permissible torque even at high gear ratios. Accordingly, these products are ideal for applications where high permissible torque is required.

The combination of hollow shaft flat gearhead and compact brushless motor allow for a compact installation without a right-angle shaft mechanism.

Hollow shaft flat gearheads are structured to increase the space volume beyond the levels achieved with conventional parallel shaft gearheads by extending the gear shaft layout in the longitudinal direction. At the same time, the gear case has been made more rigid while the gear and bearing outer diameters have been increased. These features make it possible to provide a hollow output shaft with the parallel shaft structure, which helps increase the permissible torque and life of the product.

In addition, the parallel shaft structure ensures higher gear transmission efficiency compared to conventional right-angle shaft mechanisms.

Our brushless motors are offered as a combination type with motor and gearhead pre-assembled. This enables easy mounting to the machinery and also allows the gearhead to be replaced to change the gear ratio.

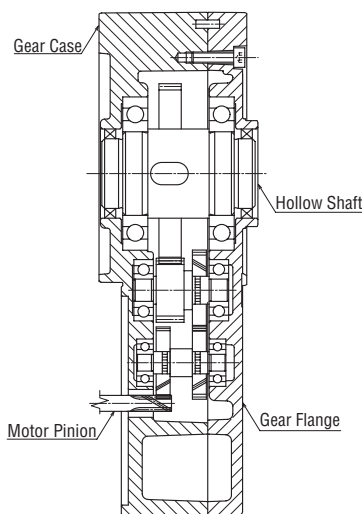

Structure of the Hollow Shaft Flat Gearhead

■ Gears for Stepping Motors and Servo Motors

Since stepping motors, servo motors and other control motors are designed to allow accurate positioning, the gearheads used for these motors must provide the same level of accuracy. Accordingly, Oriental Motor has developed a mechanism to minimize backlash in gears used with stepping motors and servo motors in order to ensure low backlash properties.

A stepping motor is generally associated with a larger output torque than an AC motor of the same size, and servo motors are high-speed. Accordingly, gears for stepping motors and servo motors support high torque and high speed so as not to reduce the characteristics of their respective motors.

The basic principles and structures of typical control motor gears are explained below.

● TH (Taper Hobbed) Gears

◇ Principle and Structure

Tapered gears are used for the final stage of the spur gear's speed-reduction mechanism and the meshing gear. Tapered gears produced through a continuous profile shifting toward the shaft. The tapered gears are adjusted in the direction of the arrows, as shown in the figure below, to reduce backlash.

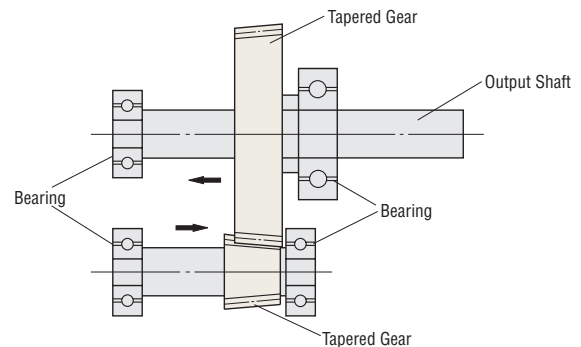
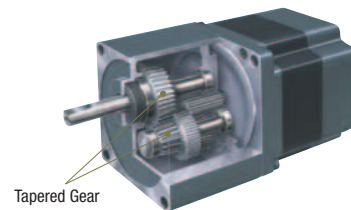

Structure of TH Gear's Final Stage

● Planetary (PS and PL) Gears

◇ Principle and Structure

The **PS** gear and **PL** gear employ a planetary gear mechanism. The planetary gear mechanism is comprised mainly of a sun gear, planetary gears and an internal tooth gear. The sun gear is installed on the central axis (in a single stage type, this is the motor shaft) surrounded by planetary gears enclosed in an internal tooth gear centered on the central axis. The revolution of planetary gears is translated into rotation of the output shaft via carriers.

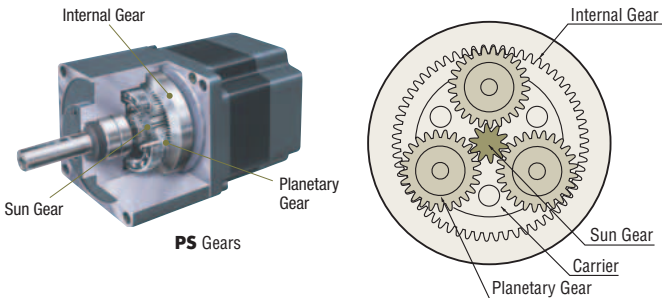

Cross Section of a **PS** Gear or **PL** Gear

- Sun Gear: A gear located in the center, functioning as an input shaft.
- Planetary Gears: Several external gears revolving around the sun gear. Each planetary gear is attached to the carrier, onto which the gear's output shaft is securely fixed.
- Internal Gear: A cylindrical gear affixed to the gearbox, having teeth on its inside diameter.

◇ High Permissible Torque

In conventional spur-gear speed reduction mechanisms, gears mesh one to one, so the amount of torque is limited by the strength of each single gear. On the other hand, in the planetary gear speed reduction mechanism, a greater amount of torque can be transmitted, since torque is distributed through dispersion via several planetary gears.

The torque applied to each gear in the planetary gear speed reduction mechanism is obtained through the following formula:

$$T = k \frac{T'}{n} \quad T: \text{Torque applied to each planetary gear [N·m (oz-in)]}$$

T' : Total torque transference [N·m (oz-in)]

n : Number of planetary gears

k : Dispersion coefficient

The dispersion coefficient indicates how evenly the torque is dispersed among the individual planetary gears. The smaller the coefficient, the more evenly the torque is dispersed and the greater the amount of torque that can be transferred. To evenly distribute the transferred torque, each component must be accurately positioned.

● Planetary (PN) Gears

◇ Principle and Structure

The **PN** gear employs a planetary gear mechanism just like the **PS** gear and **PL** gear. The **PN** gear achieves the specified backlash of three arc minutes through the improved accuracy of its components and the backlash-elimination mechanism. That mechanism is comprised of two sets of internal and planetary gears on the upper and lower levels with the internal gear teeth twisted in the circumferential direction. The upper internal gears and planetary gears reduce clockwise backlash; the lower internal gears and planetary gears reduce counterclockwise backlash.

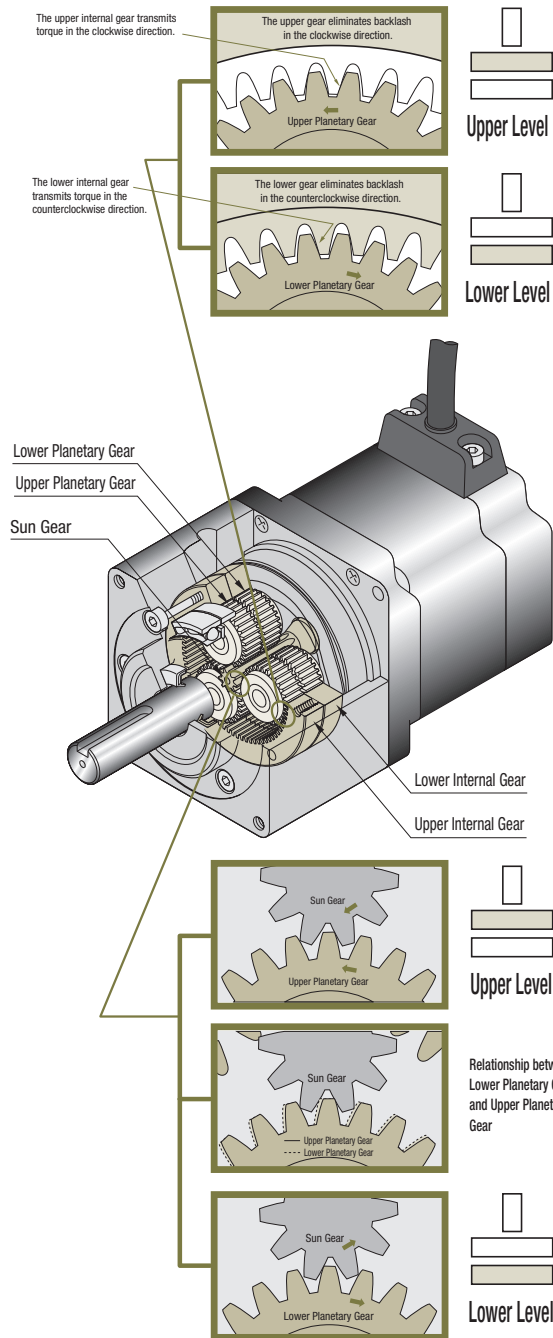

◇ High Permissible Torque

Because it adopts the same planetary gear mechanism employed by the **PS** gear and **PL** gear, the **PN** gear can also transmit torque in a dispersed manner using multiple gears and consequently achieve high permissible torque. For details, refer to “High Permissible Torque” in the sections explaining the **PS** gear and **PL** gear.

◇ Angular Transmission Accuracy

Angular transmission accuracy is the difference between the theoretical angle of rotation of the output shaft, as calculated from the input pulse count, and actual angle of rotation. Represented as the difference between the minimum value and maximum value in the set of measurements taken for one rotation of the output shaft, starting from an arbitrary position.

Frame Size [mm (in.)]	Angular Transmission Accuracy [min]
28 (1.10), 42 (1.65)	6 (0.1°)
60 (2.36)	5 (0.083°)
90 (3.54)	4 (0.067°)

- Motors
- Linear and Rotary Actuators
- Selection Calculations
- Cooling Fans
- Service Life
- Stepping Motors
- Servo Motors
- Standard AC Motors
- Brushless Motors/AC Speed Control Motors
- Gearheads
- Linear and Rotary Actuators
- Cooling Fans

● Harmonic Gears

◇ Principle and Structure

The harmonic gear offers unparalleled precision in positioning and features a simple structure utilizing the metal's elastodynamics property. It is comprised of three basic components: a wave generator, flex spline and circular spline.

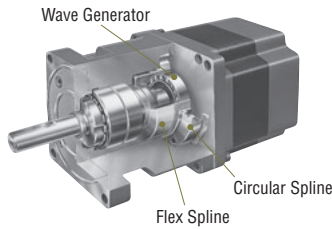

● Wave Generator

The wave generator is an oval-shaped component with a thin ball bearing placed around the outer circumference of the oval cam. The bearing's inner ring is attached to the oval cam, while the outer ring is subjected to elastic deformation via the balls. The wave generator is mounted onto the motor shaft.

● Flex Spline

The flex spline is a thin, cup-shaped component made of elastic metal, with teeth formed along the outer circumference of the cup's opening. The gear's output shaft is attached to the bottom of the flex spline.

● Circular Spline

The circular spline is a rigid internal gear with teeth formed along its inner circumference. These teeth are the same size as those of the flex spline, but the circular spline has two more teeth than the flex spline. The circular spline is attached to the gearbox along its outer circumference.

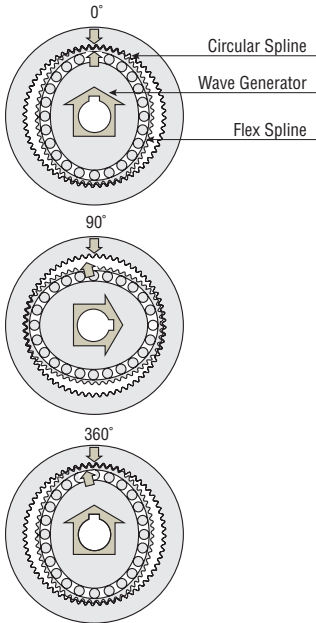

Combines three basic parts. The flex spline is bent into an oval shape by the wave generator. The teeth at the long axis of the oval mesh with the circular spline, while the teeth at the short axis of the oval are completely separate from it.

Rotating the wave generator (input) clockwise while keeping the circular spline fixed in position will subject the flex spline to elastic deformation, causing a gradual shift in the point of engagement between the circular spline and flex spline.

When the wave generator completes one revolution, the flex spline has rotated two fewer teeth than the circular spline has, resulting in the movement of flex spline for the difference in the tooth count (two teeth) in the opposite direction of the wave generator's rotation (i.e., counterclockwise). This movement translates into output, thereby reducing the speed.

◇ Precision

Unlike conventional spur gears, the harmonic gear is capable of averaging the effects of tooth pitch errors and accumulated pitch errors to the rotational accuracy, thus achieving highly accurate, non-backlash performance. However, the gear's own torsion may become the cause of a problem when performing ultra-high accuracy positioning of two arc minutes or less. When using a harmonic gear for ultra-high accuracy positioning, remember the following 4 points.

● Angular Transmission Accuracy

Angular transmission accuracy is the difference between the theoretical angle of rotation of the output shaft, as calculated from the input pulse count, and actual angle of rotation. Represented as the difference between the minimum value and maximum value in the set of measurements taken for one rotation of the output shaft, starting from an arbitrary position.

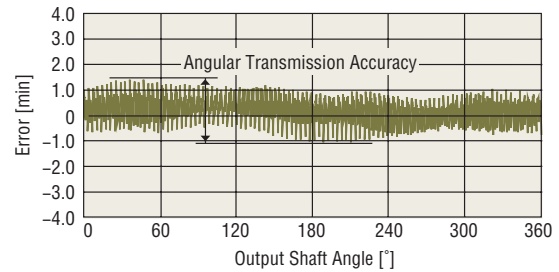

Model	Angular Transmission Accuracy [min]
CRK513-H □	3 (0.05°)
AR24-H □, CRK523-H □	2 (0.034°)
AR46-H □ RK543-H □, CRK543-H □	1.5 (0.025°)
AR66-H □ RK564-H □, CRK564-H □	

This is the value under no load (gear reference value). In actual applications there is always frictional load, and displacement is produced as a result of this frictional load. If the frictional load is constant, the displacement will be constant for uni-directional operation. However, in bi-directional operation, double the displacement is produced over a round trip. This displacement can be inferred from the following torque - torsion characteristics.

• Torque – Torsion Characteristics

The torque - torsion characteristics in the graph measure displacement (torsion) when the motor shaft is fixed and the load (torque) is gradually increased and decreased in the forward and reverse directions of the output shaft. When a load is applied to the output shaft in this way, displacement occurs due to the gear's spring constant.

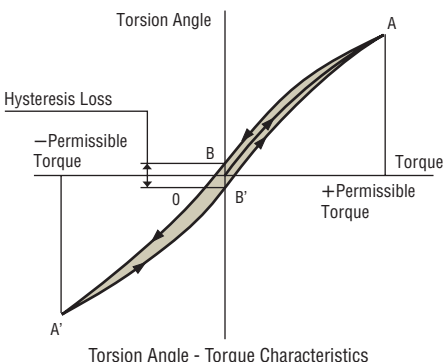

This displacement occurs when an external force is applied when the gear is stopped, or when the gear is driven under a frictional load. The slope can be approximated with the spring constant in the following three classes, depending on the size of the torque, and can be inferred through calculation.

1. Load torque T_L is T_1 or less.

$$\theta = \frac{T_L}{K_1} \text{ [min]}$$

2. Load torque T_L is greater than T_1 but not larger than T_2 .

$$\theta = \theta_1 + \frac{T_L - T_1}{K_2} \text{ [min]}$$

3. Load torque T_L is greater than T_2 .

$$\theta = \theta_2 + \frac{T_L - T_2}{K_3} \text{ [min]}$$

Torsion angles obtained by these formulas are for individual harmonic gears.

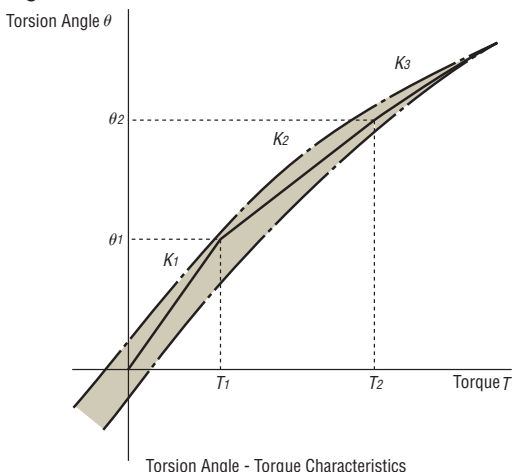

Values for Determining Torsion Angle

Model	Item	Gear Ratio	T_1	K_1	θ_1	T_2	K_2	θ_2	K_3
			N·m (lb-in)	N·m/min (lb-in/min)	min	N·m (lb-in)	N·m/min (lb-in/min)	min	N·m/min (lb-in/min)
CRK513-H50	50	50	0.075 (0.66)	0.03 (0.26)	2.3	0.22 (1.94)	0.04 (0.35)	5.9	0.05 (0.44)
			0.075 (0.66)	0.04 (0.35)	1.7	0.22 (1.94)	0.05 (0.44)	4.5	0.06 (0.53)
AR24-H50	50	50	0.29 (2.5)	0.08 (0.7)	3.7	—	0.12 (1.06)	—	—
			0.29 (2.5)	0.12 (1.06)	2.6	0.75 (6.6)	0.17 (1.50)	5.4	0.2 (1.77)
AR24-H100	100	100	0.29 (2.5)	0.1 (0.88)	2.9	1.5 (13.2)	0.15 (1.32)	11	0.21 (1.85)
			0.29 (2.5)	0.21 (1.85)	1.4	0.75 (6.6)	0.24 (2.1)	3.4	0.26 (2.3)
AR46-H50 RK543-H50 CRK543-H50	50	50	0.8 (7)	0.64 (5.6)	1.25	2 (17.7)	0.87 (7.6)	2.6	0.93 (8.2)
			0.8 (7)	0.79 (6.9)	1.02	2 (17.7)	0.99 (8.7)	2.2	1.28 (11.3)
			0.8 (7)	0.99 (8.7)	2	6.9 (61)	1.37 (12.1)	5.6	1.66 (14.6)
AR46-H100 RK543-H100 CRK543-H100	100	100	0.8 (7)	0.79 (6.9)	1.02	2 (17.7)	0.99 (8.7)	2.2	1.28 (11.3)
			2 (17.7)	0.99 (8.7)	2	6.9 (61)	1.37 (12.1)	5.6	1.66 (14.6)
			2 (17.7)	1.37 (12.1)	1.46	6.9 (61)	1.77 (15.6)	4.2	2.1 (18.5)
AR66-H50 RK564-H50 CRK564-H50	50	50	7 (61)	3.8 (33)	1.85	25 (220)	5.2 (46)	5.3	6.7 (59)
			7 (61)	4.7 (41)	1.5	25 (220)	7.3 (64)	4	8.4 (74)
AR66-H100 RK564-H100 CRK564-H100	100	100	7 (61)	3.8 (33)	1.85	25 (220)	5.2 (46)	5.3	6.7 (59)
			7 (61)	4.7 (41)	1.5	25 (220)	7.3 (64)	4	8.4 (74)

• Hysteresis Loss

When torsion torque is gradually applied to the gear output shaft until it reaches the permissible torque in the clockwise or counterclockwise direction, the torsion angle will become smaller as the torque is reduced. However, the torsion angle never reaches 0, even when fully returned to its initial level. This is referred to as "hysteresis loss," as shown by B-B' in the figure.

Harmonic gears are designed to have a hysteresis loss of less than two minutes. When positioning in the clockwise or counterclockwise direction, this hysteresis loss occurs even with a friction coefficient of 0. When positioning to two minutes or less, positioning must be done in a single direction.

• Lost Motion

Lost motion is the total value of the displacement produced when about 5% of permissible torque is applied to the gear's output shaft. Since harmonic gears have no backlash, the measure indicating the gear's accuracy is represented as lost motion.

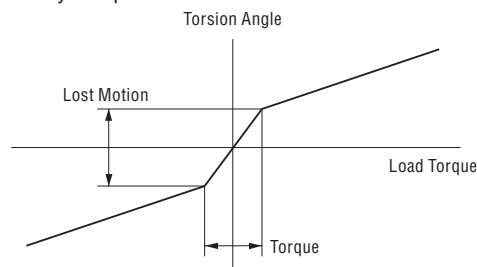

● PJ Gears

PJ gears are planetary gears with high strength and high accuracy, developed for use in **NX** series servo motor units.

◇ Principle and Structure

Like the **PN** gear, the **PJ** gear also achieves the specified backlash of three minutes (0.05°) or less through the improved accuracy of its components and the backlash eliminator with twisting upper and lower internal gears. For details, refer to "Principle and Structure" in the section explaining the **PN** gear.

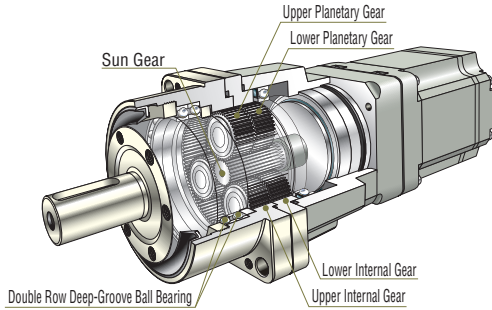

◇ High Permissible Torque

Because it adopts the same planetary gear mechanism employed by the **PL** gear, **PS** gear, and **PN** gear, the **PJ** gear can also transmit torque in a dispersed manner using multiple gears and consequently achieve high permissible torque. For details, refer to "High Permissible Torque" in the sections explaining the **PS** gear and **PL** gear. Also, because the internal gears and case are integrated in **PJ** gears, the space volume is increased beyond the levels achieved with conventional planetary gears, and the gears have a larger diameter. They are stronger as a result, and achieve a strength that can handle the maximum instantaneous torque of an **NX** servo motor.

Speed - torque characteristics **NX1075AS-J25-3**

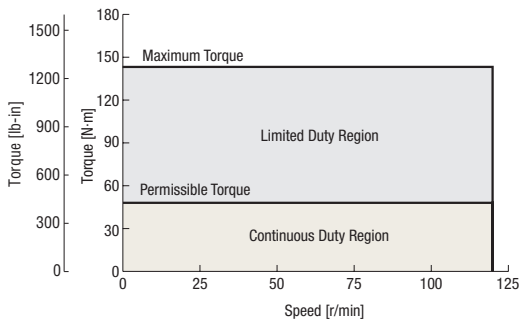

◇ Improved Permissible Thrust Load and Moment Load

PJ gears employ an output shaft configuration, with which direct load installation is possible. As a result, the thrust load and moment load must be received by the output shaft. Double row deep-groove ball bearings are used in the output shaft of **PJ** gears, meaning that a high permissible thrust load and moment load are achieved. Calculate moment load with the following formula.

$$M \text{ [N}\cdot\text{m]} = F \text{ [N]} \times L \text{ [m]}$$

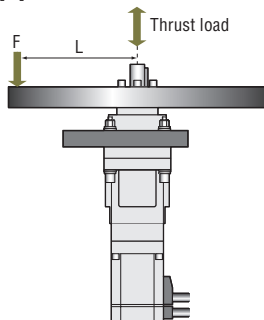

Permissible Thrust Load and Moment Load of **PJ** Gear

Gear ratio	Permissible Thrust Load [N (lb)]	Permissible Moment Load [N-m (lb-in)]
5	500 (112)	30 (260)
10	650 (146)	66 (580)
25	1000 (220)	120 (1060)

◇ Angular Transmission Accuracy

Angular transmission accuracy is the difference between the theoretical angle of rotation of the output shaft, as calculated from the input pulse count, and actual angle of rotation. Represented as the difference between the minimum value and maximum value in the set of measurements taken for one rotation of the output shaft, starting from an arbitrary position.

Frame Size [mm (in.)]	Angular Transmission Accuracy [min]
104 (4.09)	4 (0.067°)

■ Utilization of Maximum Torque

The following section describes how to utilize maximum torque, which **PS** gears, **PN** gears and harmonic gears have.

Maximum torque is the maximum torque value that can be applied to an output gear shaft.

Permissible torque is the torque that is continuously applied to an output gear shaft.

During acceleration and deceleration, a larger amount of torque than during operation at constant speed is applied to the output gear shaft as acceleration torque, due to load inertia.

The following formula shows that acceleration torque increases as load inertia increases, or as acceleration/deceleration time decreases. As a result, the positioning time is shorter as the torque applied to the output gear shaft increases.

$$T_a \text{ [N}\cdot\text{m]} = \frac{(J_o + J_L)}{9.55} \cdot \frac{N_M}{t_i}$$

T_a : Acceleration torque [N-m]

J_o : Rotor inertia [kg-m²]

J_L : Total load inertia [kg-m²]

N_M : Operating speed of motor [r/min]

t_i : Acceleration (deceleration) time [s]

t_o : Positioning time [s]

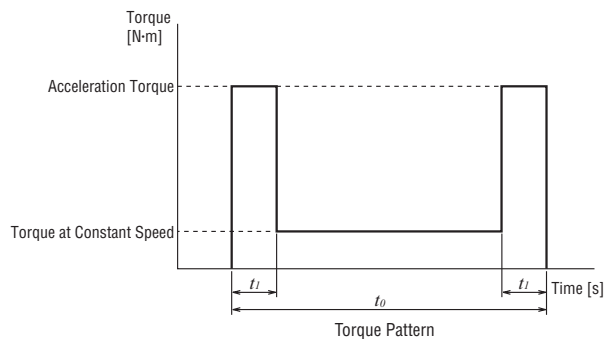
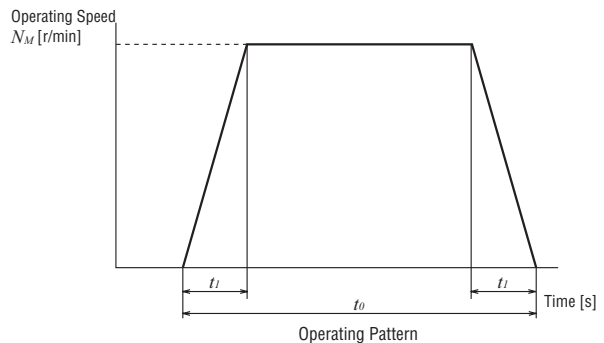

Here, when the same size inertia body is driven, positioning times are compared as an example of maximum torque being utilized. An **AR66AC-PS50-3** is used, and the speed - torque characteristics are shown below.

- Conditions ① Maximum torque utilized
 ② Gears with only permissible torque assumed
- Driving conditions Safety factor: 1.5
 Diameter of load inertia:
 300 mm (11.8 in.) [15 mm (0.59 in.) thick, iron]
 Load inertia:
 $942 \times 10^{-4} [\text{kg}\cdot\text{m}^2]$ (0.0052 [oz-in²])
 Traveling amount: 90 degrees

Item	AR66AC-PS50-3
Frame Size	60 mm (2.36 in.)
Gear Ratio	50
Maximum Holding Torque	8 N·m (70 lb-in)
Permissible Torque	8 N·m (70 lb-in)
Maximum Torque	20 N·m (177 lb-in)
Mass	0.75 kg (1.65 lb.)

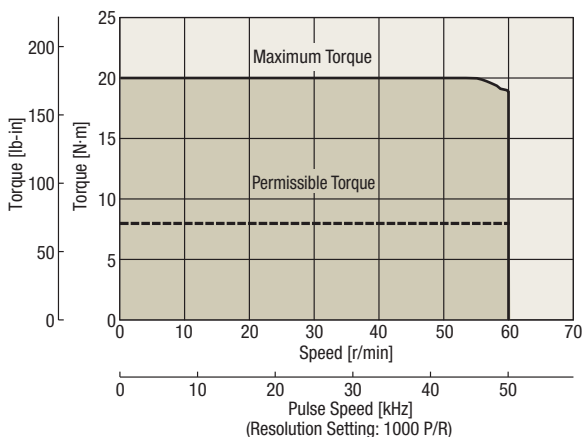

The graphs below comparing torque patterns and positioning times show that positioning time is faster at 0.1 [s] or more when maximum torque is utilized.

As demonstrated above, positioning time is faster when maximum torque is utilized, which can lead to increased productivity.

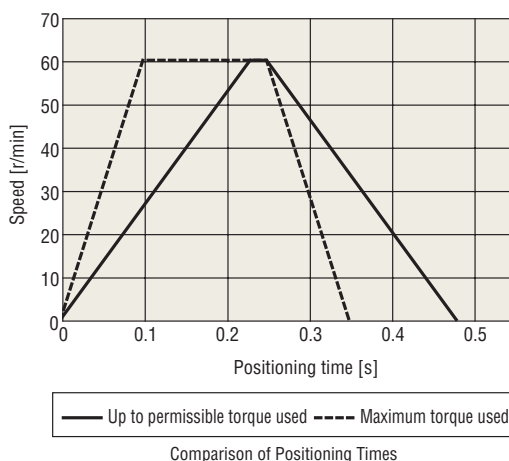
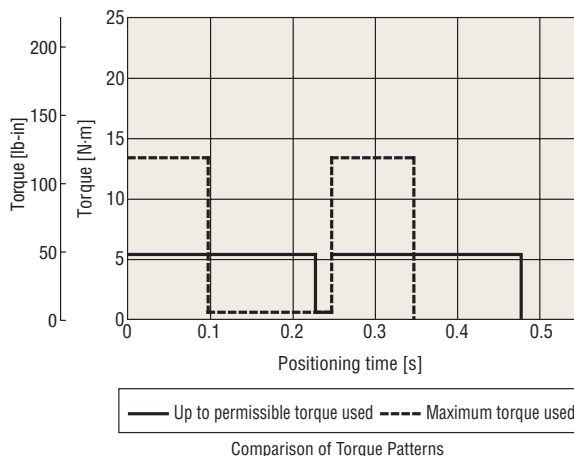

- Motors
- Selection Calculations
- Linear and Rotary Actuators
- Cooling Fans
- Service Life
- Stepping Motors
- Servo Motors
- Standard AC Motors
- Brushless Motors/AC Speed Control Motors
- Gearheads
- Linear and Rotary Actuators
- Cooling Fans

Linear and Rotary Actuators

Linear Guide Types of Motorized Linear Slides and Motorized Cylinders

The linear guides used in Oriental Motor's motorized linear slides and selected motorized cylinders are made by THK. The table below lists the products of linear guides used by each series.

Series	Product	Linear Guide Type
EZSII Series	EZS3	SRS12WM
	EZS4	SRS15WM
	EZS6	SRS15WM×2 Blocks in Contact
SPV Series	SPV6	RSR15ZM · E
	SPV8	RSR15WZM · E×2 Blocks in Contact
EZA Series	EZA4	SRS9WM
	EZA6	SRS12WM×2 Blocks in Contact

Maintenance of Motorized Linear Slides and Motorized Linear Slides

The lubrication system QZ and LM guide ball retainer significantly extend the maintenance intervals. Oriental Motor's motorized linear slides and motorized linear cylinders require maintenance of grease as part of normal maintenance.

We have evaluated and confirmed that up until the respective expected life distance for each series, our products should have no problems, even if not maintained with grease and are operated at the maximum load and maximum speed.

However, routine maintenance is still required according to the specification conditions.

The timing of normal maintenance varies depending on the operating conditions and operating environment. If grease on the raceways of the ball screw or linear guide appears dull or the amount of grease has decreased, change to new grease.

Item	Check Item	Action
Ball Screw Shaft	Attachment of dust or other foreign object?	Remove foreign objects, if any.
	Grease dull or its amount decreased?*	Clean the screw shaft using a soft cloth and then apply grease to the nut raceway grooves.
Guide Rail	Attachment of dust or other foreign object?*	Remove foreign objects, if any.
	Grease dull or its amount decreased?*	Clean the ball raceway grooves on both sides of the guide rail using a soft cloth and then apply grease to the ball raceway grooves.

* Even if the color of the grease has changed to brown, good lubrication is maintained as long as the traveling surface appears shiny.

List of Greases Used on Actuators

Series	Ball Screw	Linear Guide
EZSII Series/ EZA Series	AFF (Manufactured by THK)	AFF (Manufactured by THK)
SPV Series	–	AFB-LF (Manufactured by THK)
PWAI Series	AFB-LF (Manufactured by THK)	–

Note

- This is the belt slider **SPV** series. The belt can be replaced.
For details, refer to the Maintenance Procedures. The Maintenance Procedures can be downloaded from our website.

Deflection of Motorized Linear Slides Tables

The below example assume a moment acting upon a linear slide table which is supported by a linear guide. The action of moment causes balls in the linear guide to deflect. As a result, the load is displaced. Actual displacements measured when a load moment was caused to act upon a linear slide are shown below.

Measurement Conditions

A 100 mm overhung plate was fixed on a linear slide table and dynamic permissible moments (M_P , M_V , M_R) were caused to act upon the linear slide table in respective directions. The displacement of the tip was measured under these conditions.

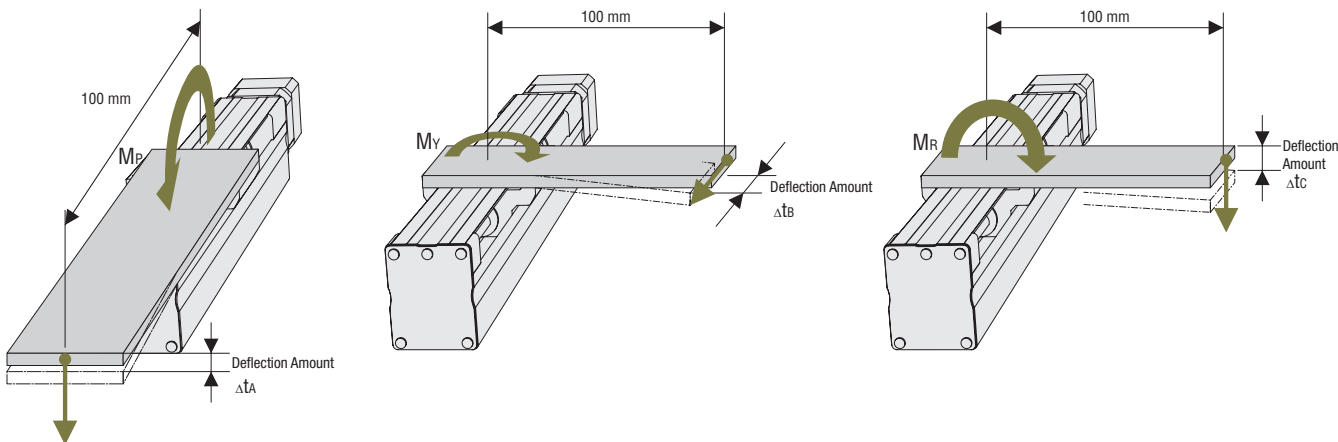

Table Deflection of Each Series under Moment

Unit [mm]

Series	Product	Δt_a	Δt_b	Δt_c
EZSII Series	EZS3	0.11	0.14	0.14
	EZS4	0.09	0.12	0.17
	EZS6	0.10	0.19	0.04

*Deflection of the 100 mm plate is ignored.

*Deflection characteristics do not change among the table types.

- Motors
- Selection Calculations
- Linear and Rotary Actuators
- Cooling Fans
- Service Life
- Stepping Motors
- Servo Motors
- Standard AC Motors
- Brushless Motors/AC Speed Control Motors
- Gearheads
- Linear and Rotary Actuators
- Cooling Fans

Repetitive Positioning Accuracy of Compact Linear Actuators DRL Series

Take proper precautions in order to ensure observance of the repetitive positioning accuracy requirements provided in the specifications.

- ① Sufficient rigidity for peripheral equipment
 - The linear-guide and other mechanical components to be used with the actuator should have rigidity sufficient to withstand the load mass and external forces. Insufficient rigidity may cause deflection, which will prevent the actuator from meeting the requirements defined in the specifications.
 - The mounting brackets used for installation of the actuator and the load attachment brackets should also have rigidity sufficient to withstand the load mass and external forces. Insufficient rigidity may cause deflection, which will prevent the actuator from meeting the requirements defined in the specifications.
- ② Sensor
 - Use a high accuracy home sensor (photo micro sensor etc.). Home positioning accuracy is not included as part of the repetitive positioning accuracy.
- ③ Temperature rise in actuator
 - The actuator may generate a significant amount of heat, depending on the drive conditions. The heat thus generated will cause the internal ball screw to elongate, resulting in displacement as shown in the following figure (reference value). To minimize the temperature dependent effects on the repetitive positioning accuracy, control the input current to the actuator and provide a design that allows for adequate heat ventilation in peripheral equipment.

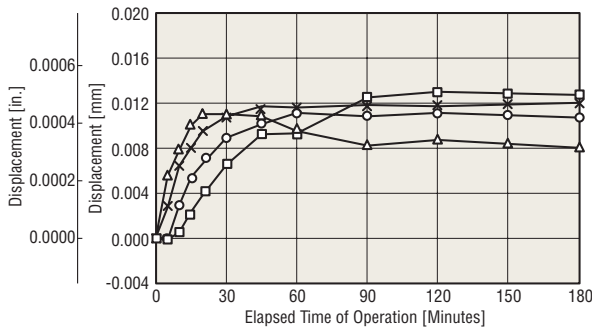

▲ DRL20PB1G-02G × DRL28PB1G-03G
 ○ DRL42PA2G-04G □ DRL60PA4G-05G

Conditions
 Current cutback : OFF
 Running duty : 80%
 Measurement method : Using a laser displacement meter

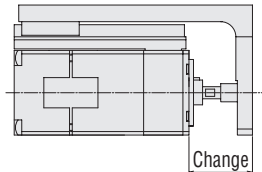

[Reference]

The temperature rise in actuator changes when the actuator's input current is adjusted. This method is effective when there is an ample allowance in starting characteristics and holding force.

DRL42 Relationship between Operating Current and Temperature Rise

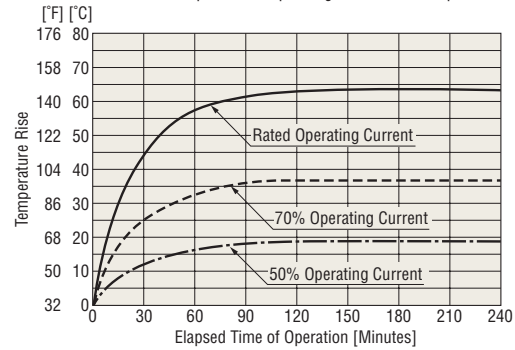

In addition to the factors mentioned above, changing the running duty also affects the temperature rise. (The above graph assumes a running duty of 75%.)

Grease Maintenance

If the grease on the screw shaft and linear guide of the compact linear actuator has become dirty, wipe it off thoroughly with a cloth and then apply new grease. The grease should be inspected once after the first week of operation, and then once a month after that. The grease used for maintenance of the **DRL** Series is shown below.

Series	Ball Screw	Linear Guide
DRL Series (Ground Ball Screw and Rolled Ball Screw Type)	AFF (Manufactured by THK)	Multemp PS No.2 (Manufactured by Kyodo Yushi)

Relationship between Cable Length and Transmission Frequency

As the pulse line cable becomes longer, maximum transmission frequency decreases. Specifically, the resistive component and stray capacitance of the cable cause the formation of a CR circuit, thereby delaying the pulse rise and fall times.

Stray capacitance in a cable occurs between electrical wires and ground planes. However, it is difficult to provide distinct numerical data, because conditions vary according to the cable type, layout, routing and other factors.

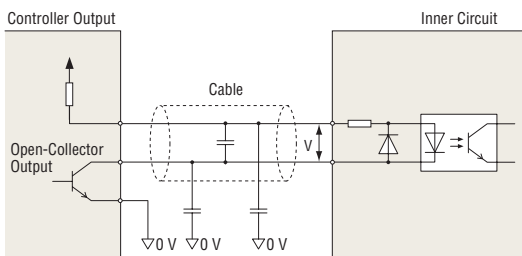

Image Diagram of Stray Capacitance in a Cable

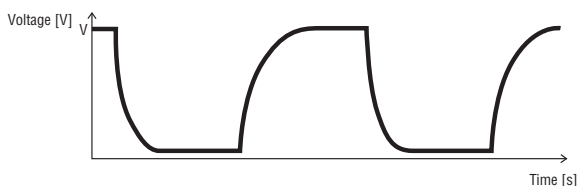

Image of Pulse Waveform

The transmission frequency when operated in combination with our products (actual-measurement reference values) are shown below:

Maximum Transmission Frequency (Reference value)

Driver	Controller	Cable	Maximum Transmission Frequency
DG Series	EMP400 Series	CC01EMP4 [1 m (3.3 ft.)]	150 KHz
		CC02EMP4 [2 m (6.6 ft.)]	120 KHz

Glossary

Motorized Linear Slides and Motorized Cylinders

Positioning Time Coefficient

Multiplying the positioning time coefficient by the positioning time needed when the linear slide is operated at the maximum ratings provides the positioning time required at the maximum speed corresponding to the applicable stroke. The longer the stroke, the lower the maximum drivable speed becomes in order to prevent the ball screw from reaching a critical speed. (For the positioning time coefficient of each product, refer to "Positioning distance – positioning time.")

Operation Duty

The ratio of the time spent by the linear slide to perform one operation to the time during which it is stopped (= operating ratio of the motor).

Oriental Motor's linear slides should not exceed at an operation duty of more than 50%. If the operation duty exceeds 50%, the motor surface temperature may rise to 100°C or above and the motor life will be reduced as a result.

If the ambient temperature remains at or below the maximum allowable ambient temperature specified for each product +40°C, the motor surface temperature should not exceed 100°C as long as the operation duty remains 50% or below. If the operation duty will exceed 50%, take appropriate measures to keep the motor surface temperature under 100°C.

Overhung Load

Overhung load is the load applied in a direction perpendicular to the output shaft (rod) of the cylinder. Please note that a permissible value is determined for each product, and that an overhung load is not applied to all products.

Acceleration/Deceleration Rate

Acceleration rate indicates the change in speed per unit time. Acceleration rate is expressed in "m/s²" when the international system of units (SI) is followed, or in the gravitational unit of "G" based on gravitational acceleration rate. The conversion formula is as follows:

$$1 \text{ G} \doteq 9.807 \text{ m/s}^2$$

With Oriental Motor's controllers (except for linear motion controllers), acceleration rate is referred to as "acceleration/ deceleration rate." The unit of acceleration/deceleration rate is ms/kHz. The conversion formula is as follows:

$$\text{Acceleration/deceleration rate [ms/kHz]} = \frac{\text{Resolution [mm]} \times 10^3}{\text{Acceleration rate [m/s}^2\text{]}}$$

Repetitive Positioning Accuracy

This is a value for constant temperature and constant load conditions indicating the variation error of accuracy of the stop position that generates when positioning is performed repeatedly to the same positioning point in the same direction.

Grease

The class of lubricants applied to smooth out the movement of guides and moving parts of the ball screw. Grease forms an oil film on metal surfaces to reduce wear and friction, thereby prolonging the life and prevent rust. Linear slides require periodic maintenance of grease according to their use conditions.

● Maximum Speed

The longer the stroke, the lower the maximum speed. This is because if the ball screw rotates at the resonance point (critical speed) or faster, it resonates due to the natural frequency of the screw shaft, which makes motion impossible. Please confirm the desired maximum stroke speed from the slider/cylinder specifications. The critical speed is affected by the length of the ball screw and the diameter of the screw. The diameters of the ball screws used in each series are as follows:

Series	Product	Ball Screw Diameter [mm]
EZSII Series	EZS4/EZC4/EZA4	φ8
EZCII Series		
EZA Series		
PWAI Series	PWA6	φ20
	PWA8	φ32

● Maximum Load Moment

(Pitching direction, yawing direction, rolling direction)

The life of each linear slide is defined as a corresponding travel distance, which is affected by the moment that can be tolerated by the table. The maximum load moment indicates the maximum value of moment with which the linear slide can reach its specified life.

● Lubrication System QZ™ (Manufactured by THK)

A lubrication system that supplies an appropriate amount of lubricating oil to the raceways of the ball screw. An oil film is maintained between the rolling element and raceways, which extends the maintenance interval considerably (except **SPV** Series).

● Long-Term Maintenance-Free

Here, "maintenance" specifically refers to maintenance of grease. The maintenance interval can be extended considerably through the use of a lubrication system QZ™.

● Mounting Reference Surface

Reference surfaces used for mounting are provided on the body of the linear slide. These reference surfaces are used to install the linear slide in the same position after removal for maintenance, etc.

● Backlash

A play along the ball within the raceways of the ball screw and screw nut.

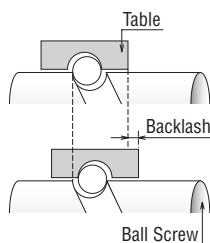

● Traveling Parallelism

The **EZSII** Series achieves high traveling parallelism because the linear guide can be used directly as the mounting surface (0.03 mm or less). The band of fluctuation in the distance between the table and reference plane when the table travels with the linear slide mounted on the reference plane is shown.

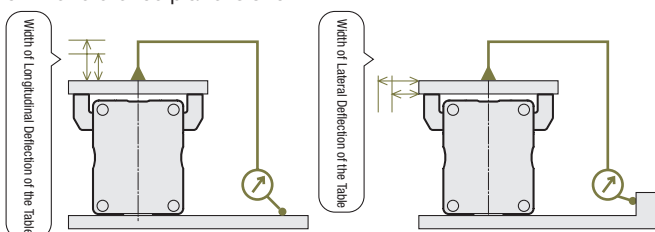

● Load Moment

When the load acting upon the table extends beyond the table in the longitudinal, lateral or vertical direction, the linear slide receives a torsional force. This torsional force is referred to as "load moment." Moments can be applied in the three directions of pitching (MP), yawing (MY) and rolling (MR), as shown below. In a condition where moment is not applied in two of these three directions, the permissible moment applied only in one direction is defined as the maximum value of moment. Permissible moments in respective directions are specified for each product.

Pitching Direction (MP)

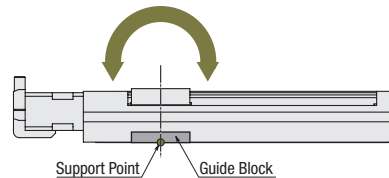

(Linear slide bottom face, center of table)

Yawing Direction (MY)

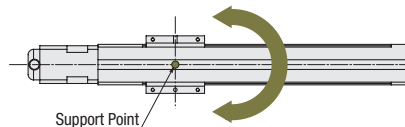

(Center of table)

Rolling Direction (MR)

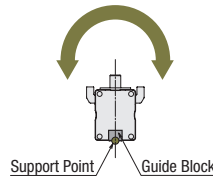

(Linear slide bottom face, center of table)

● Ball Retainer® (Manufactured by THK)

The Ball Retainer® holds individual balls in a manner preventing contact between adjacent balls and thereby allowing smooth rotation of balls. The LM Guide® adopting Ball Retainer® is structured so that the balls move along a circular path while being held by the Ball Retainer®.

This structure provides the following benefits:

- ① The balls do not make contact with each other and thus grease lasts longer, resulting in a longer life and maintenance-free period. Since grease does not splash much, less dust is produced.
- ② The balls move smoothly and generate less noise without clashing with each other.
- ③ The balls do not make contact with each other and thus less heat is generated, which makes this structure ideally suited for high-speed operation.

● Ball Retainer and LM Guide are registered trademarks of THK Co., Ltd.

● Lost Motion

The difference between positions achieved by repeated positioning operations to the same positioning point performed in the positive and negative directions.

Series	Lost Motion [mm]
EZSII Series	0.1
EZCII Series	0.15
EZA Series	0.1
PWAI Series	0.2

Controllers

● A-Phase/B-Phase Output

While the linear slide table or cylinder rod is moving, A-phase and B-phase pulses are output continuously.

- A-phase output: The table or rod position can be monitored by counting the number of output pulses.
- B-phase output: The B-phase output has a 90° phase difference compared with the A-phase output.

The traveling direction of the table or rod can be identified from the B-phase output level at the leading edge of the A-phase output pulse.

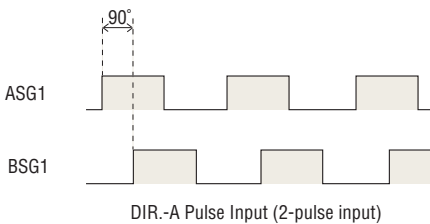

ASG1 output: Pulses corresponding to linear slide operation are output.

BSG1 output: This output is used to identify the traveling direction of the table or rod. There is a 90° phase difference compared with the ASG1 output. The traveling direction of the table or rod can be identified from the BSG1 output level at the leading edge of the ASG1 output pulse.

● HOMELS (Home sensor)

This sensor is used to determine the reference point in positioning operation. It is used during return to home operation in 3-sensor modes.

● I/O Power Supply

This power supply is needed to use I/O signals such as START input and END output. Always connect an I/O power supply.

● +LS/-LS

These are limit sensors in the positive and negative directions. They are used to prevent the linear slide table or cylinder rod from exceeding the limit position. When a +LS or -LS sensor signal is detected, the operation will stop and an alarm will generate. During return to home operation in 2-sensor mode, the position at which a +LS or -LS sensor signal is detected can be used as the home.

● Sink Logic (NPN) Specification

When the output circuit turns ON, current flows into the output circuit.

(Example) Connection of the Controllers
(EZSII, SPV, EZCII, EZA and PWAI Series)

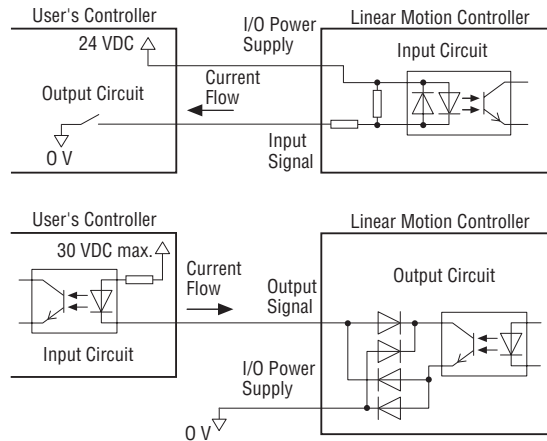

● Source Logic (PNP) Specification

When the output circuit turns ON, current flows out of the output circuit.

(Example) Connection of the Controllers
(EZSII, SPV, EZCII, EZA and PWAI Series)

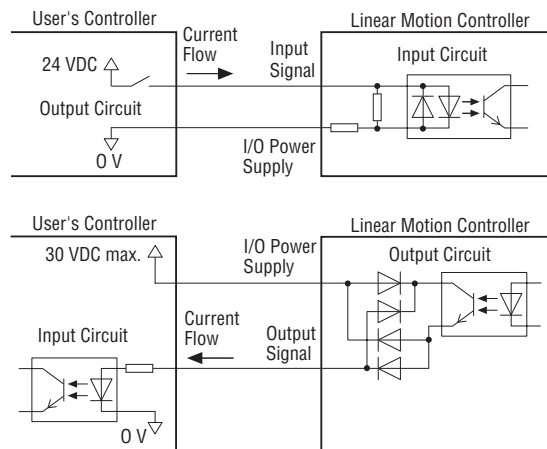

The linear motion controllers (EZSII, SPV, EZCII, EZA and PWAI Series) adopt an I/O specification that allows the controller to be used with either the NPN or PNP specification by changing the wiring.

● Positioning Completion Area

A band around the position specified in the positioning command, within which the positioning is deemed completed. When the linear slide table or cylinder rod enters this positioning completion area (specified in mm), the END output (positioning completion output) will turn ON.

● Home Offset

A home offset is used to define the home (current position = 0 mm) at a position a certain distance from the position detected in return to home operation (mechanical end or \pm LS or HOMELS position).

When a home offset is set, the linear slide will complete return to home operation and then automatically move to the home offset position before stopping.

This setting is useful when you wish to set the home at a position away from a mechanical end or when a sensor cannot be installed in the position you wish to set as the home.

(Example) Home offset = 100 mm
Return to home operation = Sensorless mode

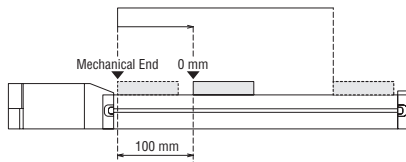

A position 100 mm away from the mechanical end is set as the home.

● Return to Home Operation

An operation to confirm the home (current position = 0 mm) for positioning operation. Return to home operation is performed in one of the following three modes:

- Sensorless mode: The position at which the table or rod contacts a mechanical end of the linear slide is set as the home. Since no sensor is used, it is also called "sensorless return to home operation."

The maximum speeds at sensorless return-to-home are as follows:

12 mm lead: 100 mm/s

6 mm lead: 50 mm/s

- 2-sensor mode: A return to home operation that uses sensors. The position at which a +LS or -LS sensor signal is detected is set as the home. Which sensor is used as the home is set in the linear motion controller.
- 3-sensor mode: Three sensors, namely +LS, -LS and HOMELS, are used. In this return to home operation, the position at which a HOMELS sensor signal is detected is set as the home.

● Controller Key

The controller key is used with linear motion controllers (**EZSI**, **SPV**, **EZCII**, **EZA** and **PWAI** Series).

The controller key stores parameters relating to linear slide and cylinder control. The following parameters are automatically set in accordance with the specifications of the linear slide and cylinder combined with the controller:

- I/O parameter: Enable or disable LS detection
- Home parameter: Return to home method
- Speed parameters: Starting speed, acceleration, deceleration, common operating speed
- Common parameter: Upper soft limit
- Internal settings (cannot be changed): Resolution, maximum operating speed, maximum acceleration/deceleration, motor control settings

Always confirm that the linear slide or cylinder model name shown on the controller key matches the linear slide model physically connected. If the two do not match, the linear slide or cylinder cannot be operated according to its specifications.

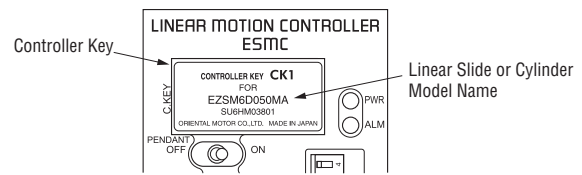

● Controller Mode, Driver Mode

- Controller mode: A mode in which data stored in the linear motion controller is used to operate the linear slide.
- Driver mode: A mode in which pulse signals output from user's controller are used to operate the linear slide.

● Main Power Supply

This power supply is needed to drive the motor. Always connect a main power supply.

The required current to be supplied from the main power supply of each linear motion controller varies depending on the linear slide and cylinder connected to the controller.

● Control Power Supply

This power supply is needed to use the linear motion controller's control functions such as data setting and operation execution. Always connect a control power supply.

● Sensor Power Supply

This power supply is needed when sensors such as \pm LS and HOMELS are connected to the linear motion controller. Always connect a sensor power supply when sensors are used.

● Soft Limits

The traveling range corresponding to the stroke is predefined in the controller. The upper limit and lower limit of the traveling range set in the linear motion controller are referred to as "+ soft limit" and "- soft limit," respectively. If the linear slide table or cylinder rod is operated to a position beyond a soft limit, the table or rod will stop at the soft limit position and an alarm will generate.

● Preset

A preset is used to change the predefined current position. You can enter a desired preset position.

(Example) When the preset position is set to 0 mm:

- ① Stop the linear slide table at the 150 mm position, and then turn the preset input ON.

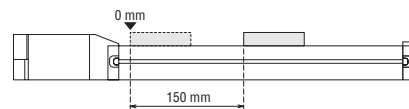

- ② In each positioning operation performed after ①, the position achieved in ① is used as the 0 mm position.

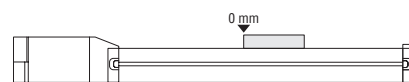

Safety and Standards

● Emergency Stop

A function to stop the machine with a single human action in order to avoid or reduce potential dangers to the man or damage to the machine or load in process.

In general, an emergency stop circuit is configured by combining mechanical parts such as relays and switches to cut off the power source (or cut off the motor power in the case of a linear slide). Stopping the motor while it is still excited, stopping the motor by the controller's stopping function or stopping the motor by using a software-operated device such as a programmable controller or personal computer, can cause malfunction due to a programming error or noise. By cutting off the motor power by non-software means, an emergency stop can be actuated more reliably. [Refer to EN ISO 13850 for details.]

● Risk Assessment

A method to enable systematic assessment of potential dangers associated with the machine. [Refer to EN ISO 12100 for details.]

Estimate risks based on the usage of the machine or potential dangers associated with machine itself and determine the necessary countermeasures. Use the risk assessment result to select the required emergency stop category and control system category.

Machines using the same linear slide may have different risk assessment results depending on the design, installation condition of safety covers over exterior surface and other conditions of each machine. You must conduct risk assessment of your specific machine to select appropriate categories.

● Stop Category

Functions to stop a machine are classified into three categories as specified below:

Stop category 0: Stop the machine by directly cutting off the power to the machine's actuator. (In the case of a linear slide, the motor power is cut off.)

Stop category 1: A controlled stop where power is supplied to stop the machine's actuator, and then the power is cut off once the actuator has stopped. (This method is used in situations where suddenly cutting off the motor power may cause other dangers.)

Stop category 2: A controlled stop where power remains supplied to the machine's actuator. (In the case of a linear slide, the linear slide is stopped while the motor is still excited.)

An emergency stop must conform to stop category 0 or 1. Which category should be selected is determined based on risk assessment of user's equipment. [Refer to EN 60204-1 (IEC 60204-1) for details.]

● Category

A classification into five levels of B and 1 to 4 of the ability to maintain safe function should a safety control system fail. [Refer to EN ISO 13849-1 for details.]

● Performance Level

The performance level is classified using five levels (a to e) regarding safety performance for the control system based on control system category, product reliability and failure detection performance.

[Refer to EN ISO 13849-1 for details.]

Motors	Selection Calculations
Linear and Rotary Actuators	
Cooling Fans	
Service Life	
Stepping Motors	
Servo Motors	
Standard AC Motors	
Brushless Motors/AC Speed Control Motors	
Gearheads	
Linear and Rotary Actuators	
Cooling Fans	

Cooling Fans

Structure of Cooling Fans

The following explains the structure of axial flow fans, centrifugal blowers and cross flow fans as well as how these fans blow air.

● Axial Flow Fans

The propellers (fan blades) located in the circular flow path between the cylindrical hub and casing are used to force-feed air in order to generate air flow in the direction of the axis of rotation.

Since air flows along the axis of rotation, the structure is kept compact. Capable of generating a large air flow, axial flow fans are suited for applications requiring ventilation cooling where the entire space inside the equipment must be cooled.

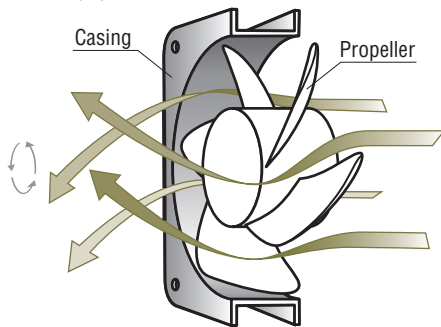

Fig. 1 Structure and Air Flow Mechanism of Axial Flow Fans

● Centrifugal Blowers

The centrifugal force of the cylindrically positioned runner (forward-facing blades) generates rotational flows roughly perpendicular to the axis of rotation. The generated rotational flows are aligned in a uni-direction through scroll action and the pressure rises accordingly.

Since the exhaust outlet is reduced to focus air in a specified direction, these blowers are used for spot cooling. The static pressure is also high, which makes them a suitable choice when cooling equipment through which air cannot flow easily or when blowing air using a duct.

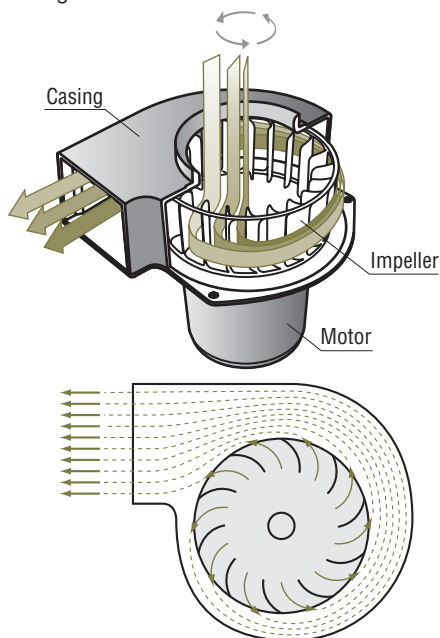

Fig. 2 Structure and Air Flow Mechanism of Centrifugal Blowers

● Cross Flow Fans

A cross flow fan has an impeller similar to that of a centrifugal blower, but both sides of the fan are covered with side panels and thus no air enters from the axial direction. As a result, air flows that pass through the impeller are generated. Cross flow fans utilize these air flows. Since a long cylindrical impeller is used to blow air, air travels over a wide width. Also, uniform air can be achieved because air is exhausted sideways along the circumference of the impeller.

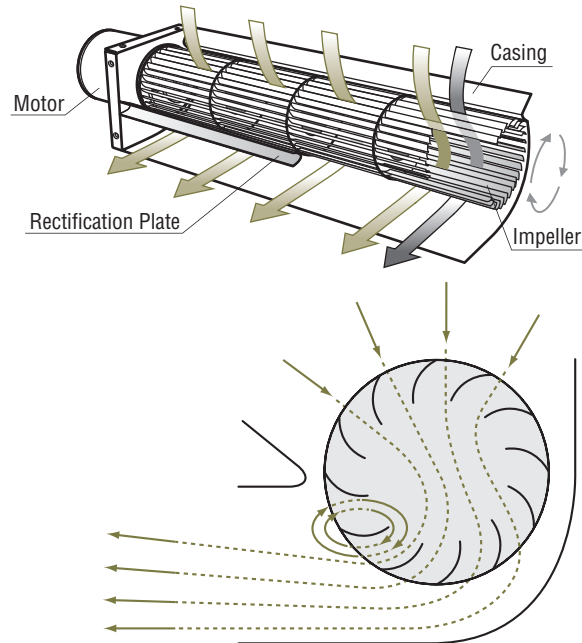

Fig. 3 Structure and Air Flow Mechanism of Cross Flow Fans

Air Flow – Static Pressure Characteristics

Pressure Loss

When air flows along a certain path, air flow resistance is produced by anything in the path that inhibits the flow. Comparing the cases illustrated in Fig. 4 and Fig. 5, we see that the device shown in Fig. 4 is almost empty, so there is almost no air flow resistance in the device and little decline in the air flow. By contrast, there are many obstructions of the air flow in the device shown in Fig. 5, which increases air flow resistance and decreases air flow. This situation is very similar to the role of impedance in the flow of electrical current: when impedance is low, the current flow is large, and when impedance is high, the current flow is low. The air flow resistance becomes the pressure energy that increases the static pressure within the device. This is called pressure loss. Pressure loss is determined using the following formula:

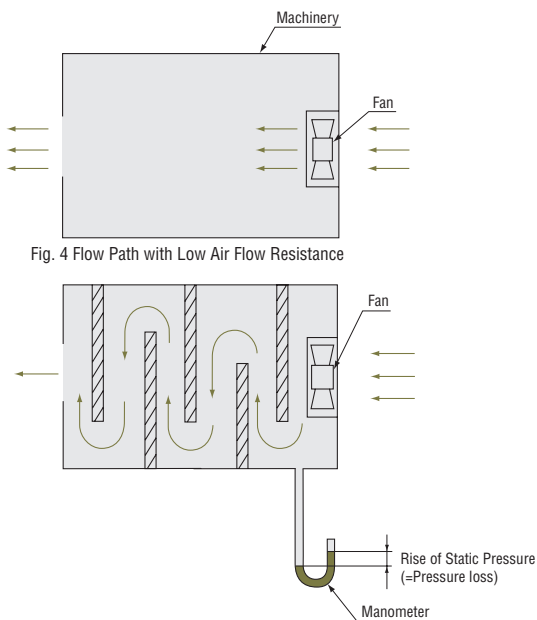

Fig. 4 Flow Path with Low Air Flow Resistance

Fig. 5 Flow Path with High Air Flow Resistance

$$\begin{aligned} \text{Pressure Loss } P &= \frac{1}{2} \xi V^2 \rho \\ &= \frac{1}{2} \xi \left(\frac{Q}{A} \right)^2 \cdot \rho \end{aligned}$$

V : Flow speed [m/s]

ρ : Air density [kg/m³]

ξ : Resistance coefficient specific to flow path

A : Cross-sectional area of flow path [m²]

Q : Air flow [m³/s]

In terms of the fan, this formula says that to achieve a certain air flow (Q), the fan must be able to supply static pressure sufficient to increase the pressure inside the device by $P = \frac{1}{2} \xi \left(\frac{Q}{A} \right)^2 \cdot \rho$.

Air Flow – Static Pressure Characteristics

Fan characteristics are generally expressed in terms of the relationship between air flow and the static pressure required to generate such air flow, given as air flow – static pressure characteristics. As an example, assume the air flow required is Q_1 and the accompanying pressure loss of the device is P_1 . When the fan characteristics are as shown in Fig. 6, the fan is capable of a static pressure of P_2 at an air flow of Q_1 . This is more than sufficient for the required air flow, since it exceeds the required static pressure value of P_1 .

Since pressure loss is proportional to the square of the air flow, if the air flow needs to be doubled, then the fan chosen must be capable of providing not only twice the air flow but four times the static pressure, as well.

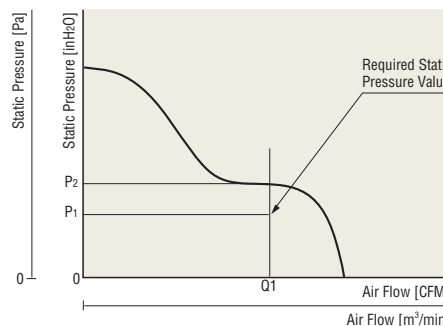

Fig. 6 Air Flow – Static Pressure Characteristics

How to Measure the Air Flow – Static Pressure Characteristics

Two methods are available for measuring the air flow – static pressure characteristics: the air-duct measurement method via the pitot tube and the double chamber measurement method. Oriental Motor employs the double chamber method, which offers higher accuracy than the air-duct method and is used worldwide. Moreover, Oriental Motor uses measuring equipment conforming to AMCA (Air Moving and Conditioning Association) standard 210, a fan measurement standard that is recognized worldwide. In the double chamber method, air flow – static pressure characteristics of the fan to be measured are obtained by measuring the pre- and post-nozzle differential pressure (ΔP) and the pressure within the chamber (P_s), as shown in Fig. 7.

(AMCA: The Air Moving and Conditioning Association)

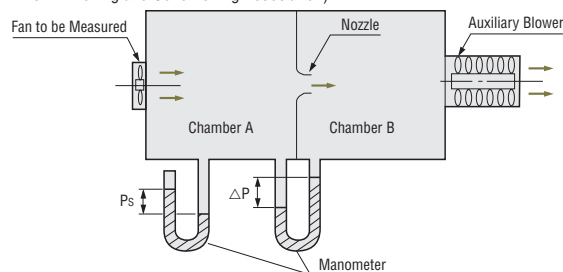

Fig. 7 Double Chamber Measuring Device

Oriental Motor's double chamber equipment is a measuring device with the highest level of general utility that may be used regardless of whether the fan is equipped with an intake or outlet tube.

Since this method allows the speed of the fluid flowing through the nozzle to be determined from the pressure differential between chambers A and B, the air flow (Q) can be expressed as a product of the flow speed (V) through the nozzle, the nozzle area (A), and the flow coefficient (C), as shown below.

$$\begin{aligned} Q &= 60CA\bar{v} \\ &= 60CA \sqrt{\frac{2\Delta P}{\rho}} \quad [\text{m}^3/\text{min}] \end{aligned}$$

A : Cross-sectional area of nozzle [m²]

C : Flow coefficient

\bar{v} : Average flow speed at the nozzle [m/sec]

ρ : Air density [kg/m³] ($\rho = 1.2$ [kg/m³] at 20°C [68°F] and 1 atm.)

ΔP : Differential pressure [Pa]

The measurement of air flow – static pressure characteristics uses an auxiliary blower to control the pressure in chamber B, altering the pressure in chamber A. Thus, each point on the characteristics curve can be measured. Oriental Motor's measuring equipment is connected to a computer, providing extremely precise measurements in a short period of time.

● Changes in Air Flow – Static Pressure Characteristics Using Two Fans

By using two fans featuring the same characteristics together, you can change the characteristics of the fans.

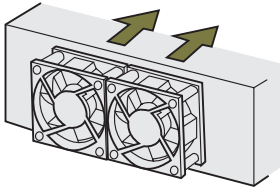

Fig. 8 When Using Two Fans

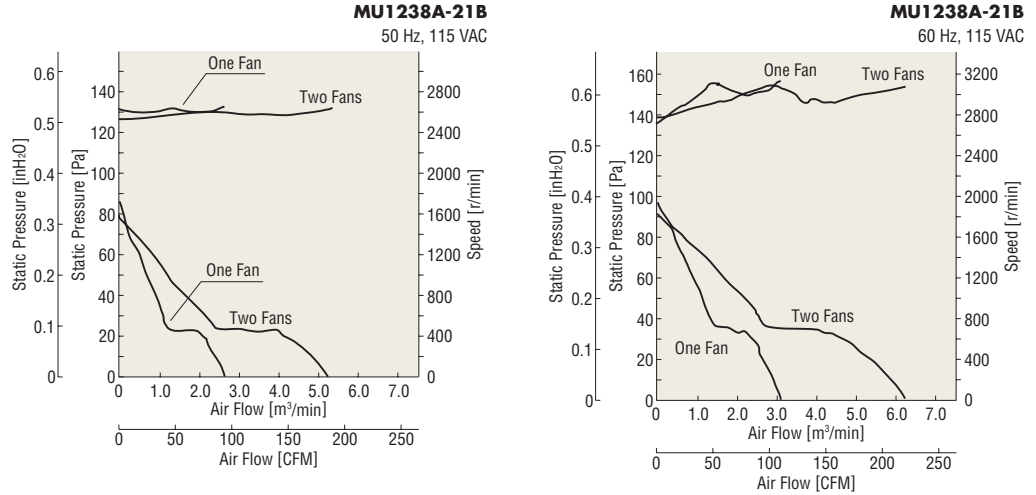

Fig. 9 Changes in Air Flow – Static Pressure Characteristics Using Two Fans

As shown in Fig. 9, the maximum air flow is approximately twice as large using two fans.

● Changes in the Air Flow – Static Pressure Characteristics with Installation of Accessories

When installing a fan in equipment, the safety and reliability of the overall apparatus can be significantly improved by attaching accessories such as finger guards and filters. However, these parts produce air flow resistance, affecting fan characteristics and fan noise. This should be taken into account when selecting fans and accessories.

The graph in Fig. 10 shows data regarding pressure loss caused by its accessories for a frame size 119 mm (4.69 in.) sq. fan. The filter causes the most significant pressure loss, while the finger guard causes little loss.

For frame size 119 mm (4.69 in.) sq. Fans

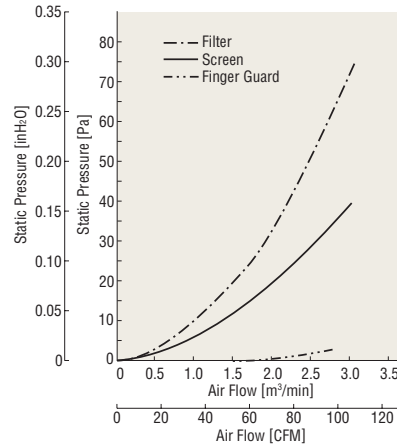

Fig. 10 Pressure Loss Caused by Accessories

The graphs in Fig. 11 show how characteristics may change with installation of accessories, using the **MU1225S-21** as an example.

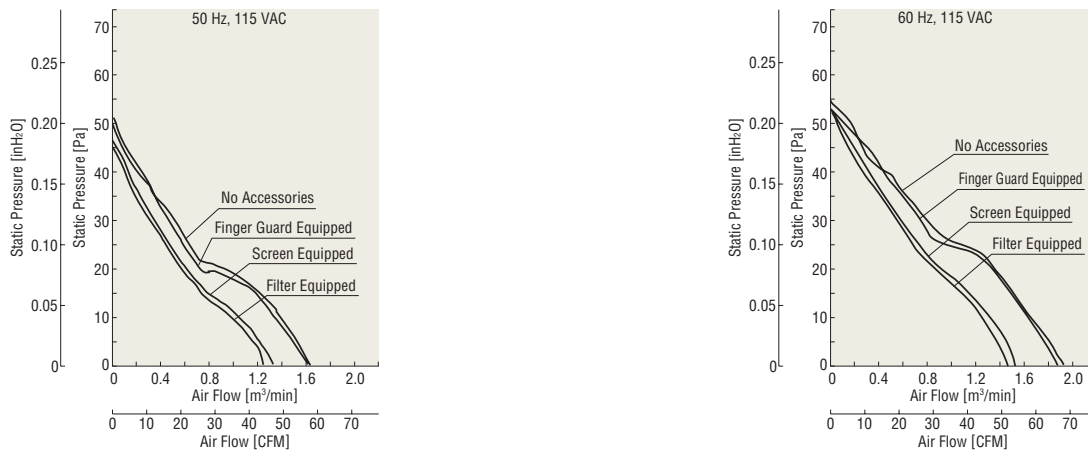

Fig. 11 Changes in Characteristics with Accessories Equipped to the **MU1225S-21**

As the Fig. 11 shows, the greater the pressure loss caused by accessories, the greater the reduction in air flow – static pressure characteristics.

Noise

What is Noise?

We generally refer to sounds that are unpleasant to us as "noise." In the case of fans, the rotation of the fan blades causes air pressure fluctuation and generates noise. The greater the change in air pressure, the louder the resulting noise will be.

Measurement of Noise

The noise level of Oriental Motor fans is measured in the A-weighted sound pressure level at a distance of 1 m (3.3 ft.) from the intake side (at a point above the center line of the intake side).

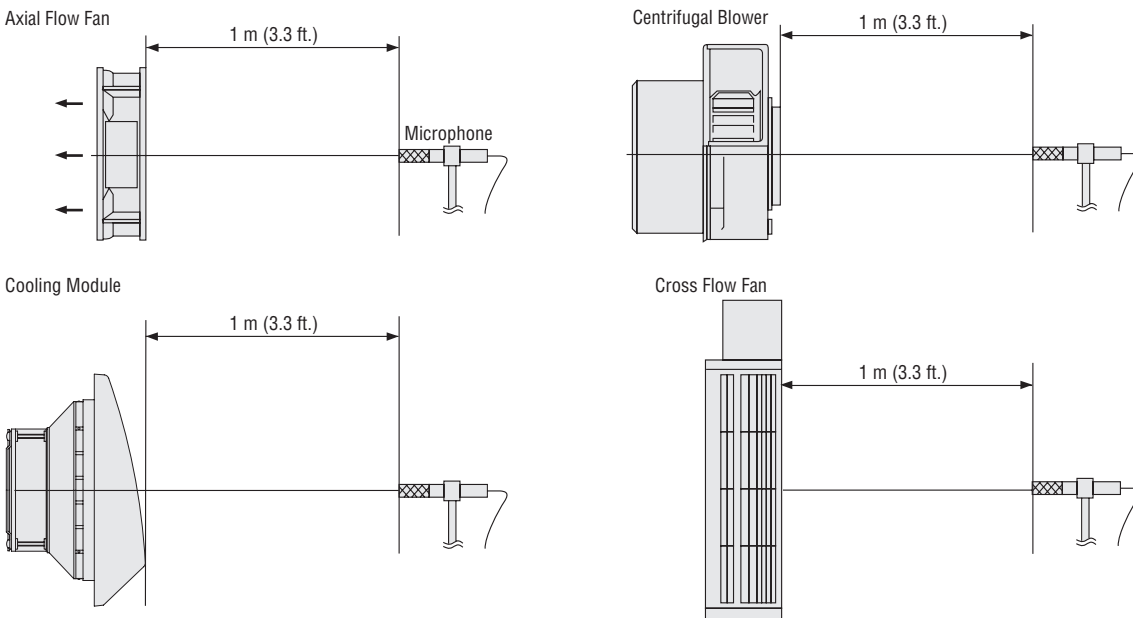

Fig. 12 How to Measure Noise

Composition of Noise

This section explains the noise level when using two fans, each of which produces 40 dB of noise.

Noise is expressed in decibel units, and noise cannot be determined simply by adding individual noise levels. The value that expresses this combined noise is found by determining the energy of the noise and then using it to calculate the increase in sound pressure.

The relationship between sound energy (J) and sound pressure (P) is expressed in the following formula: $J = \frac{P^2}{\rho c}$ where, ρ = Air density, c = Speed of sound propagation.

Using the above formula, the noise level can be expressed in decibel unit as follows:

$$\begin{aligned} \text{Noise level} &= 20 \log P/P_0 \\ &= 10 \log J/J_0 \end{aligned}$$

P : Actual sound pressure

J : Measured noise energy

P_0, J_0 : Minimum noise energy audible to the human ear

In this formula the noise level is expressed in decibels based on the reference energy of J_0 . As the noise energy for n fans is n times that of a single fan, the sound pressure obtained by this formula will be:

$$\begin{aligned} \text{Noise level} &= 10 \log n \cdot J/J_0 \\ &= 10 \log J/J_0 + 10 \log n \end{aligned}$$

In other words, when n fans are operated simultaneously, the increase in noise is equal to $10 \log n$ [dB].

In this example, if two 40 dB fans ($n = 2$) are operated simultaneously, the increase in noise level is equal to $10 \log 2$ or 3 dB, and the combined noise level is 43 dB.

The following explains the combined noise level when a 40 dB fan and a 50 dB fan are operated simultaneously. Again, the combined noise level is not given by a simple arithmetic sum but is obtained as follows:

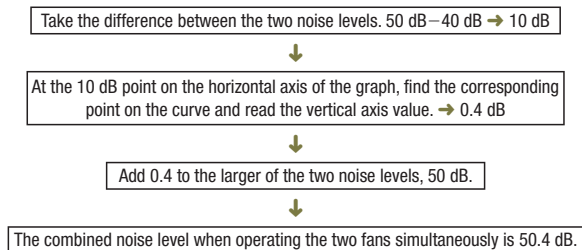

If 40 dB of noise is combined with 50 dB, the resulting increase in noise level is only 0.4 dB. In other words, the noise level is always controlled by the larger of noise values, so it is important to suppress the noise of the fan producing greater noise.

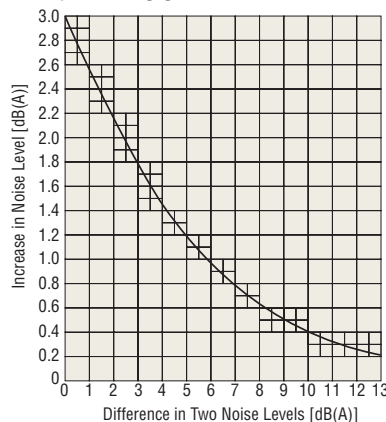

Fig. 13 Difference in Two Noise Levels and Increase in Noise Level

Distance and Noise

The noise level decreases as the distance from the sound source increases.

The decrease in noise level due to distance is given by the following formula:

$$SPL_2 = SPL_1 - 20 \log r_2/r_1$$

SPL₂: Noise level at distance r₂

SPL₁: Noise level at distance r₁

In the following example the noise level at a distance of 2 m (6.6 ft.) from the intake side of fan, whose noise level is 40 dB at a distance of 1 m (3.3 ft.) from the intake side of fan, is calculated.

Since r₂ = 2 m (6.6 ft.), r₁ = 1 m (3.3 ft.), and SPL₁ = 40 dB, substituting in the formula gives:

$$\begin{aligned} SPL_2 &= 40 - 20 \log 2/1 \\ &= 34 \text{ [dB]} \end{aligned}$$

Thus, at a distance of 2 m (6.6 ft.), the noise level decreases by 6 dB. The value 20 log r₂/r₁ in the above formula represents the ratio between two distances. Thus, if the values used above were 3 m (9.8 ft.) and 6 m (19.7 ft.), the result would have been the same. Therefore, if the noise level at a certain distance is known, the noise level at another distance can be estimated.

Capacitor

Permanent split capacitor motors contain an auxiliary winding offset by 90 electrical degrees from the main winding. The capacitor is connected in series with the auxiliary winding, causing the advance of current phase in the auxiliary winding.

Motors employ vapor-deposition electrode capacitors recognized by UL. This type of capacitor, which uses a metallized paper or plastic film as an element, is also known as a "self-healing (SH) capacitor" because of the self-healing property of the capacitor element.

Although most of the previous capacitors used paper elements, the plastic film capacitor has become a mainstream model in recent years due to the growing demand for compact design.

Capacitance

The use of a capacitor with a different capacitance may cause excessive motor vibration and heat generation or may result in torque drops and unstable operation. Be sure to use the capacitor included with the fan. The capacitor's capacitance is expressed in microfarads (μF).

Rated Voltage

Using a capacitor exceeding the rated voltage may cause damage and then smoke or ignite. Be sure to use the capacitor included with the fan. The rated voltage of the capacitor is expressed in volts (V). The capacitor's rated voltage is indicated on the surface of the capacitor case. Take proper precautions, since the capacitor's rated voltage is different from that of the fan.

Rated Conduction Time

The rated conduction time is the minimum design life of the capacitor when operated at the rated load, rated voltage, rated temperature and rated frequency. The standard life expectancy is 25000 hours. A capacitor that breaks at the end of its life expectancy may smoke or ignite. We recommend that the capacitor be replaced after the rated conduction time.

Consider providing a separate protection measure to prevent the equipment from being negatively influenced in the event of capacitor failure.

Overheat Protection Device

If a fan in run mode locks due to overload, ambient temperature rises rapidly, or the input current increases for some reason, the fan's temperature rises abruptly. If the fan is left in this state, the performance of the insulation within the fan may deteriorate, reducing its life and, in extreme cases, scorching the winding and causing a fire. In order to protect the fan from such thermal abnormalities, our fans recognized by UL and CSA Standards and conform to EN and IEC Standards are equipped with the following overheat protection device.

Thermal Protector

The **MRS** Series, **MB** Series (impeller diameter φ80 mm (3.15 in.) or more) and **MF** Series fans contain a built-in automatic return type thermal protector. The structure of a thermal protector is shown in the figure below.

The thermal protectors employ bimetal contacts, with solid silver used in the contacts. Solid silver has the lowest electrical resistance of all materials, along with a thermal conductivity second only to copper.

Operating Temperature of Thermal Protector

open 120 ± 5°C (248 ± 9°F)

close 77 ± 15°C (170.6 ± 27°F)

(The fan winding temperature, where the thermal protector is activated, is slightly higher than the operating temperature listed above.)

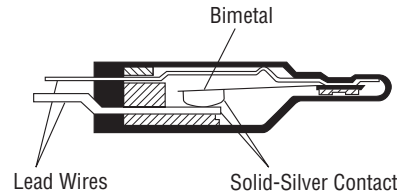

Fig. 14 Structure of Thermal Protector

Impedance Protected

The **MU** and **MB** Series (**MB520** and **MB630** type) fans are equipped with impedance protection.

Impedance protected fans are designed with higher impedance in the fan windings so that even if the fan locks, the increase in current (input) will be minimized and the temperature will not rise above a certain level.

Glossary

● Decibels (dB)

Noise level is expressed in decibel units (dB).

When the noise level is expressed based on the linear scale, with the minimum level of noise audible to the human ear being 1, the maximum level of noise the human ear can withstand is expressed in such a substantial figure as 5 million. In contrast, if noise (sound pressure level) is expressed in decibels, then

$$\text{Sound pressure level} = 20 \log P/P_0$$

P : Actual sound pressure

P_0 : Minimum sound pressure audible to the human ear

Therefore, the range of sound pressure audible to the human ear can be conveniently expressed as 0 to 130 dB.

● A-Weighted Sound Pressure Level

It is generally said that the audible range of the human ear is between 20 Hz and 20 kHz. Moreover, low frequency and extremely high frequency sounds are not disturbingly loud to the human ear. For this reason, an accurate indication of loudness as perceived by the human ear cannot be achieved simply by measuring sound pressure without taking frequency into account. Therefore, measurements of the sound pressure level must be corrected according to frequency in order to accurately reflect the human perception of loudness. This corrected level is called the A-weighted sound pressure level.

The graph below compares the corrected measured values (A-weighted sound pressure level) with the uncorrected measured values (C-weighted sound pressure level).

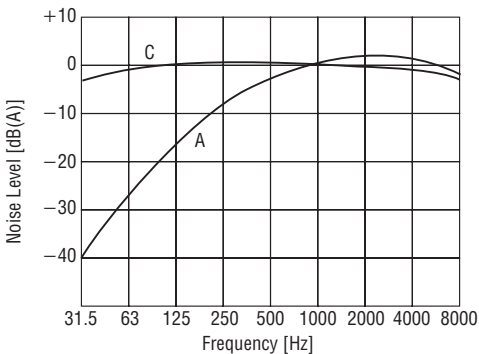

Fig. 17 Comparison of Sound Pressure Level

● Flammability Grade

The flammability grade represents the degree of fire retardancy for plastic materials used in equipment parts. The generally accepted standards for flammability grade are the UL Standards (UL94, STANDARD FOR TESTS FOR FLAMMABILITY OF PLASTIC MATERIALS FOR PARTS IN DEVICES AND APPLIANCES). The UL Standards provide the flammability of plastic materials based on the burning rate, duration of burning from the onset of fire, fire ignited by a dripping substance and other items.

Flammability grade is rated in four different grades, as shown in the table below.

Grade	Flammability Grade
V-0	High
V-1	↑
V-2	↑
HB	Low

● Cooling fans use blades and frames with materials that receive the highest grade in this classification, V-0.

