

Selection Calculations (Selecting a motorized linear slide)

After you have determined which series to use, select an appropriate model. Select a linear slide of the size that satisfies your desired condition.

Select an appropriate model by following the steps below.

- Refer to page 64 for selection calculations using a dual axes mounting bracket.

(1) Select a Linear Slide Satisfying the Transportable Mass

By referring to "■ specifications of linear slide," select a linear slide satisfying the transportable mass.

Condition: Drive a load of 15 kg over a horizontal distance of 400 mm within 1.5 seconds.

EZS4: Specifications of Width 74 mm × Height 50 mm, 24 VDC Linear Slide

■ Specifications of Linear Slide (RoHS)										CE	
Drive Method	Ball Screw	Repetitive Positioning Accuracy [mm]		±0.02	Resolution [mm]	0.01	Traveling Parallelism [mm]	0.03*	Maximum Load Moment [N·m]	Mp: 8 Mv: 8 Ma: 27.8	
Model	Lead [mm]	Transportable Mass [kg]		Thrust [N]	Electromagnetic Brake Holding Force [N]	Maximum Speed (Stroke) [mm/s]					
		Horizontal	Vertical			50~550 mm	560~600 mm	610~650 mm	660~700 mm		
EZS4D□-K	12	~15	—	~70	—	600	550	460	400		
EZS4D□M-K			~7		70						
EZS4E□-K	6	~30	—	~140	—	300	270	220	200		
EZS4E□M-K			~14		140						

● Enter the stroke length in the box (□) within the model name.
* This applies when the linear slide is installed from the base surface.

Based on the "condition" and "specifications of linear slide," select **EZS4D040-K**.

(2) Check the Positioning Time

From the graph "■ positioning distance – positioning time" below, check if the selected linear slide satisfies the desired positioning time. As a rough guideline, the positioning time required by the selected linear slide corresponds to the positioning time identified from the graph, multiplied by the "positioning time coefficient" applicable to the linear slide.

From the graph, find the "positioning time of 1.2 s" for the "positioning distance of 400 mm." You obtain the "positioning time of 1.2 s." Since the stroke is 550 mm or less, multiply "positioning time of 1.2 s" by the "positioning time coefficient of 1.0" to obtain an approximate positioning time.

Notes:

- The calculated positioning time does not include the settling time.
Use a settling time of 0.15 s as a reference.
- The running duty cycle, which represents the relationship of running time and stopping time, should be kept to 50% or less (reference).
Running duty cycle [%] = running time [s] × 100 / (running time [s] + stopping time [s])

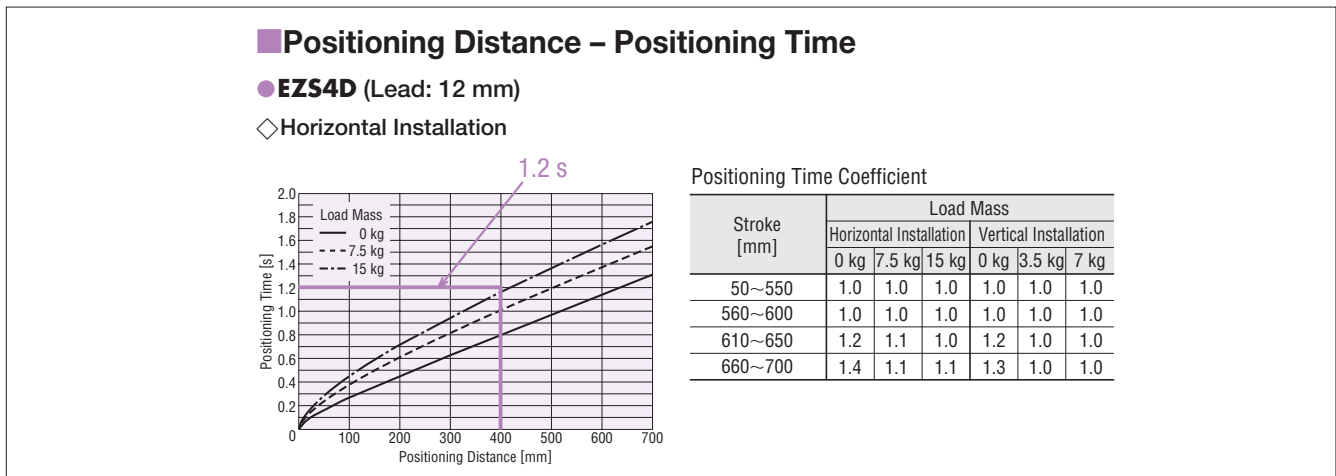

(3) Check the Operating Speed and Acceleration of the Linear Slide

The time calculated from "■positioning distance – positioning time" assumes the operating speed and acceleration that achieve the shortest positioning time. Check the specific operating speed and acceleration at which to drive the linear slide based on the time calculated in step (2).

◇ Operating Speed and Acceleration of the Linear Slide

Check the operating speed and acceleration by referring to "■positioning distance – operating speed" and "■positioning distance – acceleration." If the identified speed exceeds the maximum speed specified in specifications of linear slide, use the "maximum speed specified in ■specifications of linear slide" as the operating speed of the linear slide.

Example) For a positioning distance of 400 mm on the graph, the operating speed is 480 mm/s, and the acceleration is 1.5 m/s^2 .

EZS4D040-K "■Positioning Distance – Operating Speed"

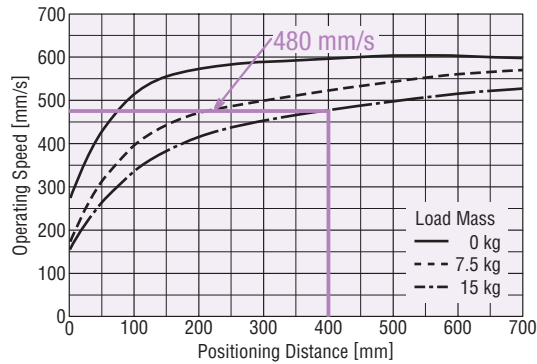

EZS4D040-K "■Positioning Distance – Acceleration"

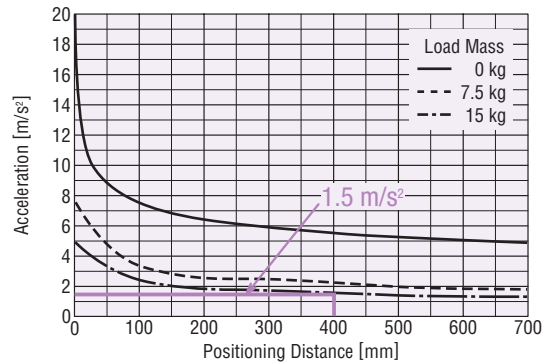

Maximum Speed by Stroke

Stroke [mm]	Maximum Speed [mm/s]
50~550	600
560~600	550
610~650	460
660~700	400

(4) Check the Load Moment

Calculate the load moment that will generate under the applicable condition, and confirm that the calculated result is smaller than the "maximum load moment specified in ■specifications of linear slide." If the maximum load moment is exceeded, select another model. The maximum load moment has been calculated by considering the estimated traveling life of each model. If a given model is operated at load moment exceeding the designed limit, the life of the linear slide will decrease. The life is also affected by the operating environment and conditions.

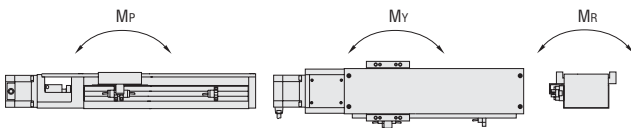

How to Calculate the Speed for Sensorless Return to Home Operation

The **EZSII** Series can perform the high-speed, sensorless return to home operation. The maximum return to home speed is 100 mm/s when the lead is 12 mm, and the maximum speed becomes 50 mm/s when the lead is 6 mm. Select an applicable calculating formula by referring to the linear slide installation conditions and calculate the maximum settable speed for return to home operation from the specific overhang length and load mass.

Note that the load will receive impact if the sensorless return to home operation is performed at high speed.

● If there are overhangs along both the Z-axis and Y-axis, compare V_z and V_y . The smaller of the two provides the maximum settable speed for return to home operation.

● Linear Slide Installation Conditions (Horizontal, wall-mounted or ceiling-mounted)

◇ Overhang in Z-Axis Direction

$$V_z [\text{mm/s}] = \frac{k \times 10^3}{mL_z} \times 100$$

[Overhang in Z direction]

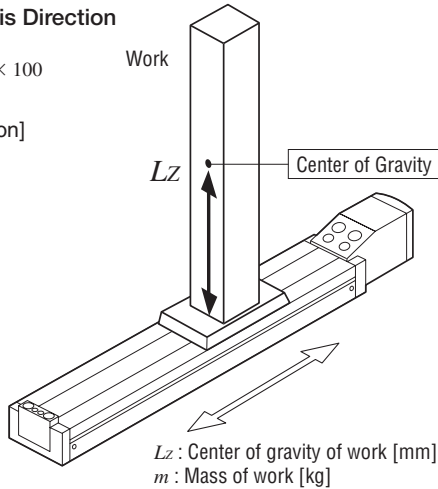

Linear Slide Size	Strength Coefficient k	
	Lead 12 mm	Lead 6 mm
EZS3	6.7	4.2
EZS4	7.1	6.3
EZS6	18.6	16.1

◇ Overhang in Y-Axis Direction

$$V_y [\text{mm/s}] = \frac{k \times 10^3}{mL_y} \times 100$$

[Overhang in Y direction]

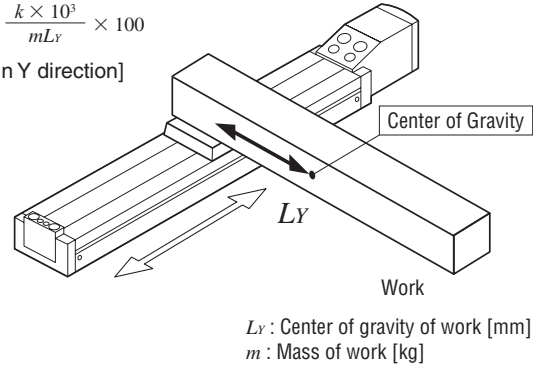

Linear Slide Size	Strength Coefficient k	
	Lead 12 mm	Lead 6 mm
EZS3	0.6	0.5
EZS4	1.7	1.5
EZS6	7.5	6.4

● Linear Slide Installation Conditions (Vertical)

If the linear slide is installed vertically, the applicable coefficient varies depending on the return to home direction (upward or downward). Use the correct coefficient according to the specific direction.

◇ Overhang in Z-Axis Direction

$$V_z [\text{mm/s}] = \left(\frac{k \times 10^3}{mL_z} + i \right) \times 100$$

[Overhang in Z direction]

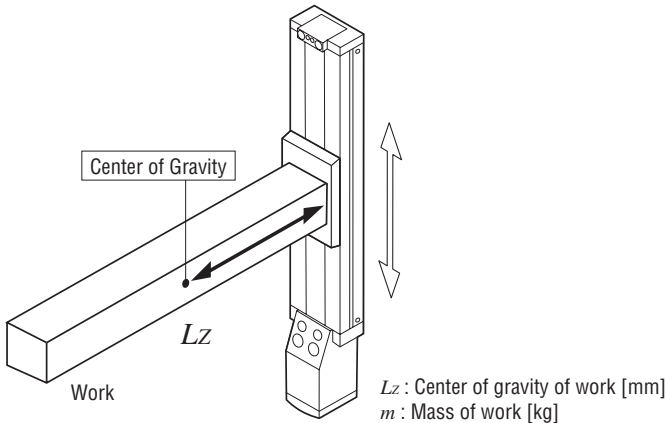

Upward:

Linear Slide Size	Strength Coefficient k		Upward Coefficient i	
	Lead 12 mm	Lead 6 mm	Lead 12 mm	Lead 6 mm
EZS3	6.7	5.7	1.8	1.5
EZS4	9.6	13.7	2.6	3.7
EZS6	20.7	51.7	2.1	5.4

Downward:

Linear Slide Size	Strength Coefficient k		Downward Coefficient i	
	Lead 12 mm	Lead 6 mm	Lead 12 mm	Lead 6 mm
EZS3	5.3	3.1	-1.5	-0.9
EZS4	5.3	3.5	-1.5	-1.0
EZS6	11.2	12.2	-1.2	-1.3

◇ Overhang in Y-Axis Direction

$$V_y [\text{mm/s}] = \left(\frac{k \times 10^3}{mL_y} + i \right) \times 100$$

[Overhang in Y direction]

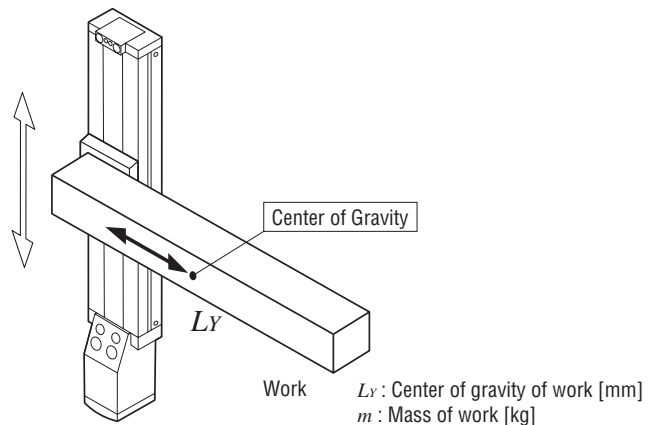

Upward:

Linear Slide Size	Strength Coefficient k		Upward Coefficient i	
	Lead 12 mm	Lead 6 mm	Lead 12 mm	Lead 6 mm
EZS3	0.7	0.6	1.8	1.5
EZS4	2.2	3.2	2.6	3.7
EZS6	8.3	20.8	2.1	5.4

Downward:

Linear Slide Size	Strength Coefficient k		Downward Coefficient i	
	Lead 12 mm	Lead 6 mm	Lead 12 mm	Lead 6 mm
EZS3	0.6	0.3	-1.5	-0.9
EZS4	1.2	0.8	-1.5	-1.0
EZS6	4.5	4.9	-1.2	-1.3

Positioning Distance – Operating Speed, Positioning Distance – Acceleration

● EZS3D□-K (Lead 12 mm, 24 VDC)

◇ Horizontal Installation

Positioning Distance – Operating Speed

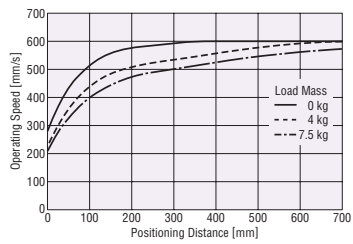

Maximum Speed by Stroke

Stroke [mm]	Maximum Speed [mm/s]
50~550	600
560~600	550
610~650	460
660~700	400

Positioning Distance – Acceleration

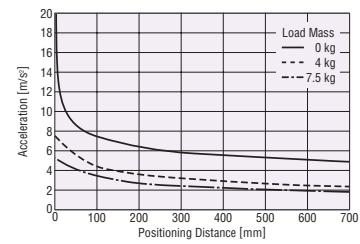

◇ Vertical Installation

Positioning Distance – Operating Speed

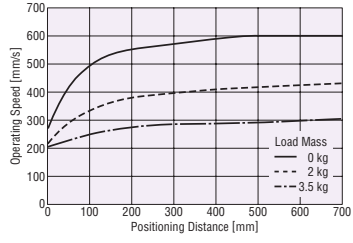

Maximum Speed by Stroke

Stroke [mm]	Maximum Speed [mm/s]
50~550	600
560~600	550
610~650	460
660~700	400

Positioning Distance – Acceleration

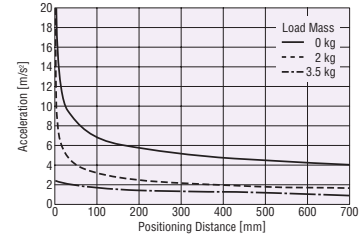

● EZS3E□-K (Lead 6 mm, 24 VDC)

◇ Horizontal Installation

Positioning Distance – Operating Speed

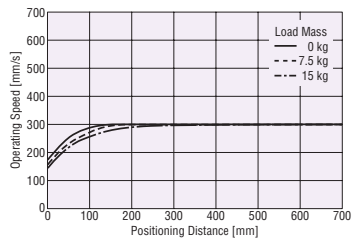

Maximum Speed by Stroke

Stroke [mm]	Maximum Speed [mm/s]
50~550	300
560~600	270
610~650	220
660~700	200

Positioning Distance – Acceleration

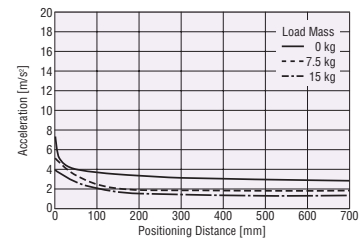

◇ Vertical Installation

Positioning Distance – Operating Speed

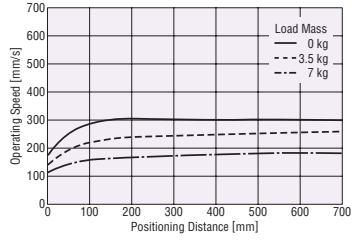

Maximum Speed by Stroke

Stroke [mm]	Maximum Speed [mm/s]
50~550	300
560~600	270
610~650	220
660~700	200

Positioning Distance – Acceleration

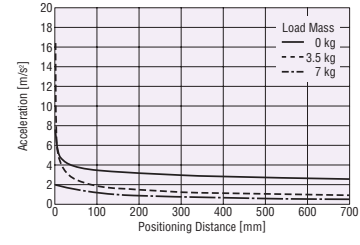

● EZS3D□-A/EZS3D□-C (Lead 12 mm, Single-Phase 100-115 VAC/Single-Phase 200-230 VAC)

◇ Horizontal Installation

Positioning Distance – Operating Speed

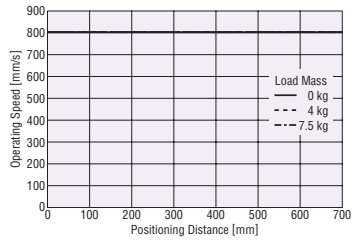

Maximum Speed by Stroke

Stroke [mm]	Maximum Speed [mm/s]
50~500	800
510~550	650
560~600	550
610~650	460
660~700	400

Positioning Distance – Acceleration

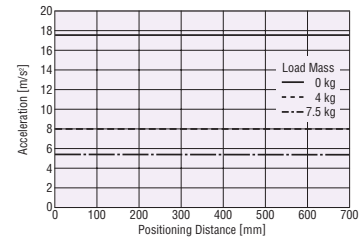

◇ Vertical Installation

Positioning Distance – Operating Speed

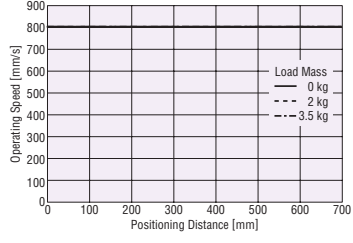

Maximum Speed by Stroke

Stroke [mm]	Maximum Speed [mm/s]
50~500	800
510~550	650
560~600	550
610~650	460
660~700	400

Positioning Distance – Acceleration

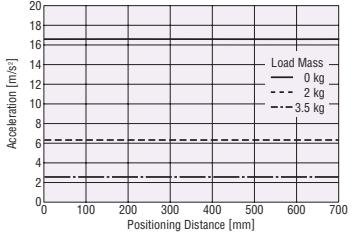

● **EZS3E□-A/EZS3E□-C** (Lead 6 mm, Single-Phase 100-115 VAC/Single-Phase 200-230 VAC)

◇ Horizontal Installation

• Positioning Distance – Operating Speed

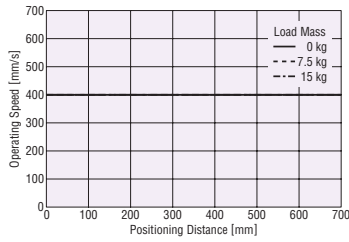

Maximum Speed by Stroke

Stroke [mm]	Maximum Speed [mm/s]
50~500	400
510~550	320
560~600	270
610~650	220
660~700	200

• Positioning Distance – Acceleration

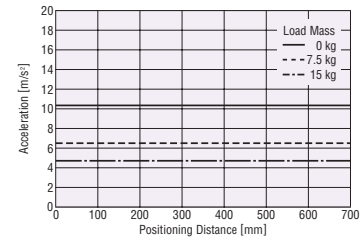

◇ Vertical Installation

• Positioning Distance – Operating Speed

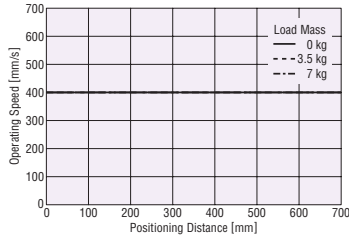

Maximum Speed by Stroke

Stroke [mm]	Maximum Speed [mm/s]
50~500	400
510~550	320
560~600	270
610~650	220
660~700	200

• Positioning Distance – Acceleration

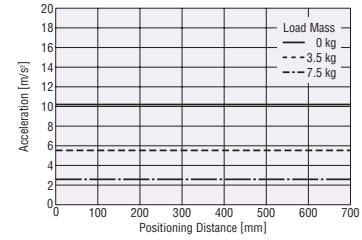

● **EZS4D□-K** (Lead 12 mm, 24 VDC)

◇ Horizontal Installation

• Positioning Distance – Operating Speed

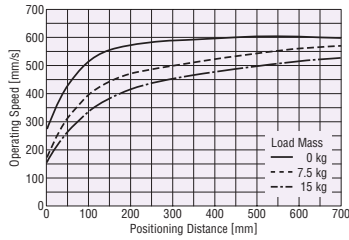

Maximum Speed by Stroke

Stroke [mm]	Maximum Speed [mm/s]
50~550	600
560~600	550
610~650	460
660~700	400

• Positioning Distance – Acceleration

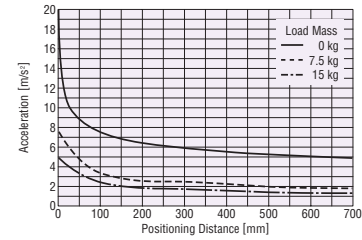

◇ Vertical Installation

• Positioning Distance – Operating Speed

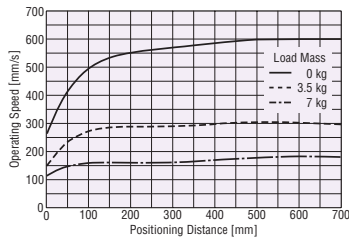

Maximum Speed by Stroke

Stroke [mm]	Maximum Speed [mm/s]
50~550	600
560~600	550
610~650	460
660~700	400

• Positioning Distance – Acceleration

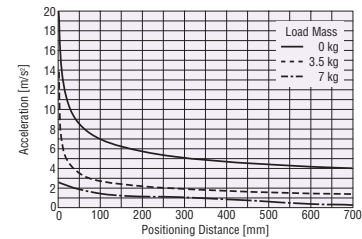

● **EZS4E□-K** (Lead 6 mm, 24 VDC)

◇ Horizontal Installation

• Positioning Distance – Operating Speed

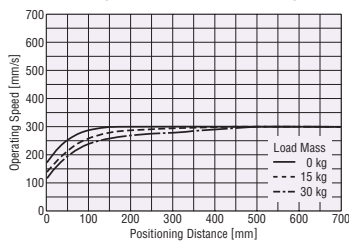

Maximum Speed by Stroke

Stroke [mm]	Maximum Speed [mm/s]
50~550	300
560~600	270
610~650	220
660~700	200

• Positioning Distance – Acceleration

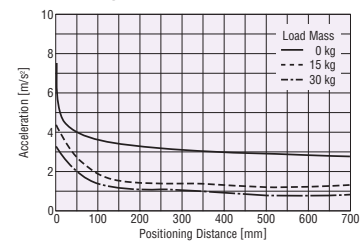

◇ Vertical Installation

• Positioning Distance – Operating Speed

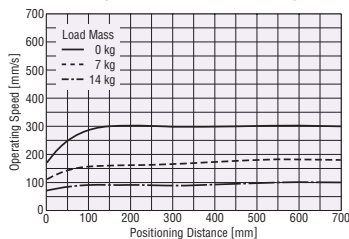

Maximum Speed by Stroke

Stroke [mm]	Maximum Speed [mm/s]
50~550	300
560~600	270
610~650	220
660~700	200

• Positioning Distance – Acceleration

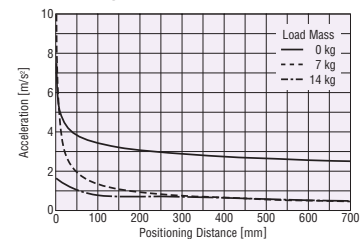

● **EZS4D□-A/EZS4D□-C** (Lead 12 mm, Single-Phase 100-115 VAC/Single-Phase 200-230 VAC)

◇ Horizontal Installation

• Positioning Distance – Operating Speed

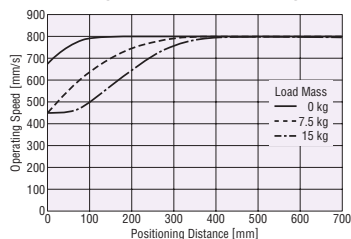

Maximum Speed by Stroke

Stroke [mm]	Maximum Speed [mm/s]
50~500	800
510~550	650
560~600	550
610~650	460
660~700	400

• Positioning Distance – Acceleration

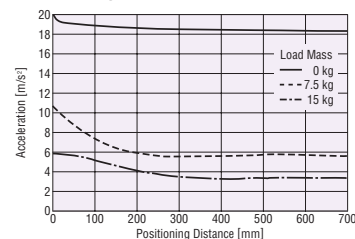

◇ Vertical Installation

• Positioning Distance – Operating Speed

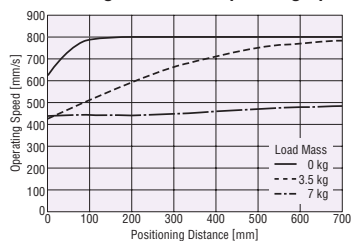

Maximum Speed by Stroke

Stroke [mm]	Maximum Speed [mm/s]
50~500	800
510~550	650
560~600	550
610~650	460
660~700	400

• Positioning Distance – Acceleration

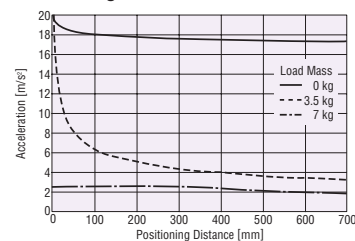

● **EZS4E□-A/EZS4E□-C** (Lead 6 mm, Single-Phase 100-115 VAC/Single-Phase 200-230 VAC)

◇ Horizontal Installation

• Positioning Distance – Operating Speed

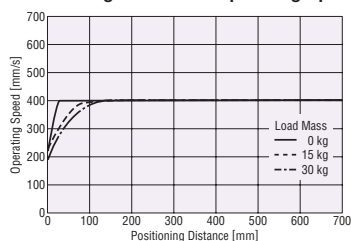

Maximum Speed by Stroke

Stroke [mm]	Maximum Speed [mm/s]
50~500	400
510~550	320
560~600	270
610~650	220
660~700	200

• Positioning Distance – Acceleration

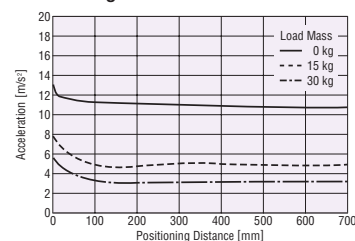

◇ Vertical Installation

• Positioning Distance – Operating Speed

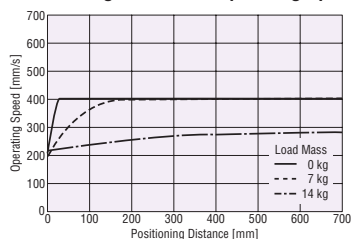

Maximum Speed by Stroke

Stroke [mm]	Maximum Speed [mm/s]
50~500	400
510~550	320
560~600	270
610~650	220
660~700	200

• Positioning Distance – Acceleration

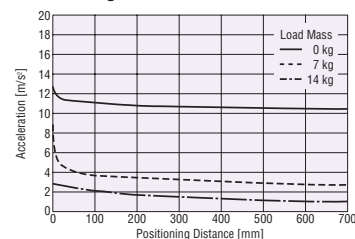

● **EZS6D□-K** (Lead 12 mm, 24 VDC)

◇ Horizontal Installation

• Positioning Distance – Operating Speed

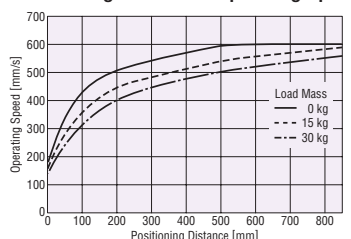

Maximum Speed by Stroke

Stroke [mm]	Maximum Speed [mm/s]
50~650	600
660~700	550
710~750	470
760~800	420
810~850	360

• Positioning Distance – Acceleration

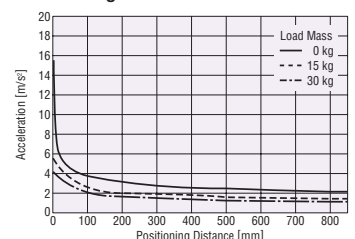

◇ Vertical Installation

• Positioning Distance – Operating Speed

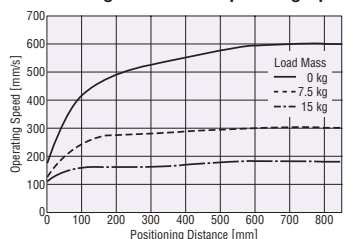

Maximum Speed by Stroke

Stroke [mm]	Maximum Speed [mm/s]
50~650	600
660~700	550
710~750	470
760~800	420
810~850	360

• Positioning Distance – Acceleration

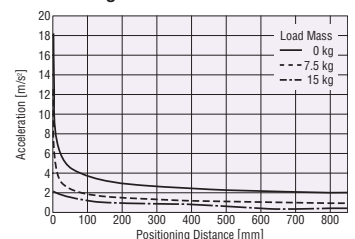

● **EZS6E□-K** (Lead 6 mm, 24 VDC)

◇ Horizontal Installation

• Positioning Distance – Operating Speed

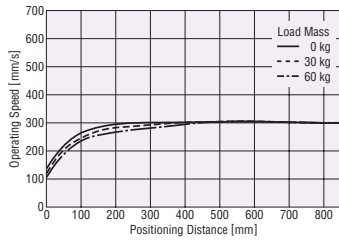

Maximum Speed by Stroke

Stroke [mm]	Maximum Speed [mm/s]
50~650	300
660~700	260
710~750	230
760~800	200
810~850	180

• Positioning Distance – Acceleration

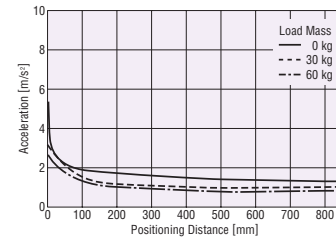

◇ Vertical Installation

• Positioning Distance – Operating Speed

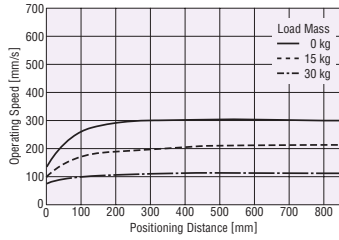

Maximum Speed by Stroke

Stroke [mm]	Maximum Speed [mm/s]
50~650	300
660~700	260
710~750	230
760~800	200
810~850	180

• Positioning Distance – Acceleration

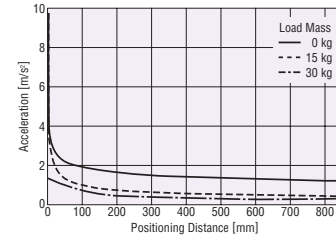

● **EZS6D□-A/EZS6D□-C** (Lead 12 mm, Single-Phase 100-115 VAC/Single-Phase 200-230 VAC)

◇ Horizontal Installation

• Positioning Distance – Operating Speed

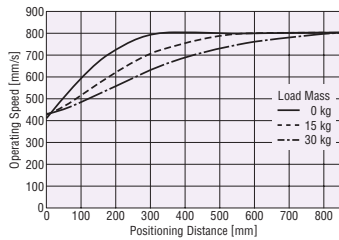

Maximum Speed by Stroke

Stroke [mm]	Maximum Speed [mm/s]
50~600	800
610~650	640
660~700	550
710~750	470
760~800	420
810~850	360

• Positioning Distance – Acceleration

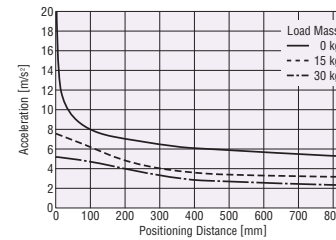

◇ Vertical Installation

• Positioning Distance – Operating Speed

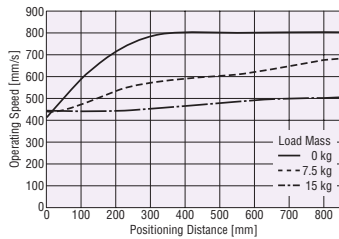

Maximum Speed by Stroke

Stroke [mm]	Maximum Speed [mm/s]
50~600	800
610~650	640
660~700	550
710~750	470
760~800	420
810~850	360

• Positioning Distance – Acceleration

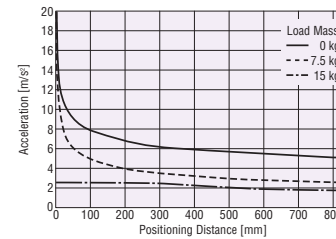

● **EZS6E□-A/EZS6E□-C** (Lead 6 mm, Single-Phase 100-115 VAC/Single-Phase 200-230 VAC)

◇ Horizontal Installation

• Positioning Distance – Operating Speed

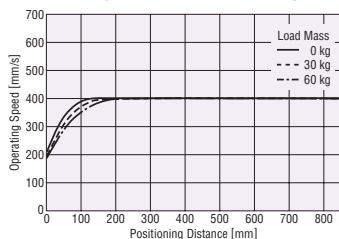

Maximum Speed by Stroke

Stroke [mm]	Maximum Speed [mm/s]
50~550	400
560~600	350
610~650	300
660~700	260
710~750	230
760~800	200
810~850	180

• Positioning Distance – Acceleration

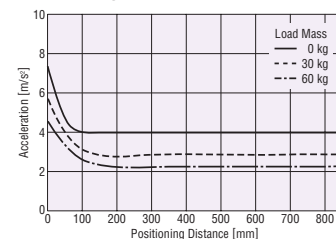

◇ Vertical Installation

• Positioning Distance – Operating Speed

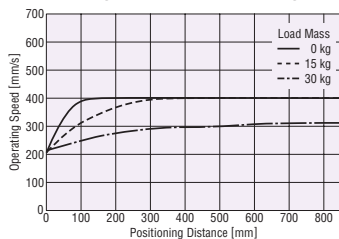

Maximum Speed by Stroke

Stroke [mm]	Maximum Speed [mm/s]
50~550	400
560~600	350
610~650	300
660~700	260
710~750	230
760~800	200
810~850	180

• Positioning Distance – Acceleration

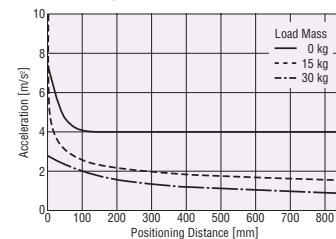

Overview

Selection

System
Configuration

Product Line

Specifications

Connection
and Operations

Accessories

Selection Calculations

Selection Calculations (Using a dual axes mounting bracket)

The following explains the calculation when using a dual axes mounting bracket dedicated to the **EZSII** Series. Required dual axes mounting bracket is determined by selecting any dual axes combination of the **EZSII** Series based on your conditions. You can select an optimum combination by following the procedure.

Selection Procedure

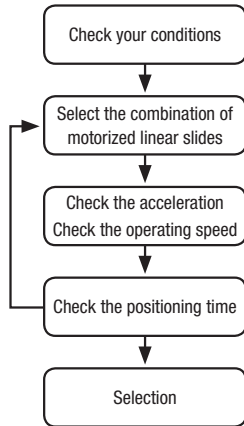

Select the combination of motorized linear slides using the table of transportable mass per acceleration. Once the combination is determined, you can figure out required dual axes mounting bracket.

Find an acceleration from the table of transportable mass per acceleration, and check a speed of each axis in the speed – transportable mass characteristics graph.

Calculate a positioning time. Check if your preferred positioning time can be met.

Example of Selection

Follow the procedure for selection based on the following conditions.

Conditions

- Load 3 kg mass in X-Y mounting with 100 mm in 0.5 s.
- Operating range is 500 mm in X-axis and 250 mm in Y-axis.
- The center of gravity for work in Y-axis: $(G_1, G_2, G_3) = (45, 20, 25)$
- Power supply voltage: 24 VDC input

(1) Select the Combination of Motorized Linear Slides and Dual Axes Mounting Bracket

Check the combination of motorized linear slides using the "transportable mass per acceleration" table (Refer to page 66). Find the maximum absolute value within G_1, G_2, G_3 . As the conditions state $|G_1| = 45$ is the maximum value, check the table for center of gravity conditions of $30 < |G_n| \leq 50$. The following combination of linear slides can bear a mass of 3 kg with a 250 mm stroke.

[Combination 1] X-axis: **EZS6D** Y-axis: **EZS3D**
or

[Combination 2] X-axis: **EZS6D** Y-axis: **EZS4D**

Select [Combination 1] as the smaller product size.

The following products are tentatively selected.

X-axis: **EZS6D050-K**

Y-axis: **EZS3D025-K**

EZS6D is tentatively selected for the first axis, and **EZS3D** for the second. As the second axis stroke is 250 mm, and the combination pattern (Refer to page 45) is **R**-type, the required dual axes mounting bracket can be determined as **PAB-S6S3R025**.

(2) Check the Acceleration of Linear Slides

Check an acceleration from the "transportable mass per acceleration" table.

The maximum acceleration is 2.5 m/s^2 when a transportable mass is 3 kg.

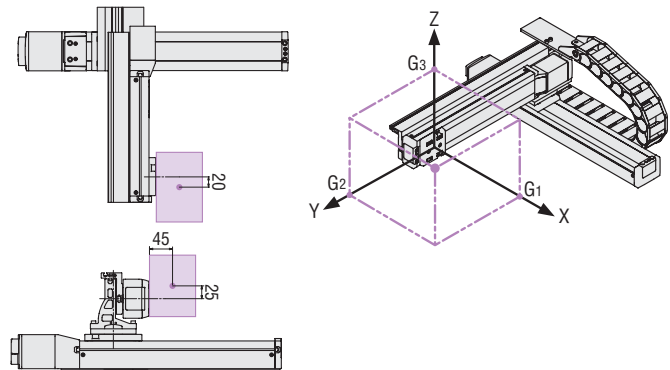

Transportable Mass per Acceleration

● X-Y Mounting Y-axis transportable mass [kg]

		30 < G _n ≤ 50					
		Stroke [mm]					
X-axis: EZS4D Y-axis: EZS3D	Acceleration	50	100	150	200	250	300
	1.0 m/s ²	2.0	1.6	1.3	1.0	0.7	0.4
	2.5 m/s ²	1.1	0.8	0.5	0.2	—	—
	5.0 m/s ²	0.3	—	—	—	—	—
X-axis: EZS6D Y-axis: EZS3D	Acceleration	50	100	150	200	250	300
	1.0 m/s ²	4.1	4.1	4.1	4.1	4.1	4.1
	2.5 m/s ²	3.3	3.3	3.3	3.3	3.3	3.3
	5.0 m/s ²	2.6	2.6	2.6	2.6	2.6	2.6
X-axis: EZS6D Y-axis: EZS4D	Acceleration	50	100	150	200	250	300
	1.0 m/s ²	8.7	8.7	8.7	8.1	7.0	6.0
	2.5 m/s ²	7.0	7.0	7.0	6.3	5.3	4.5
	5.0 m/s ²	5.3	5.3	5.2	4.3	3.6	2.9

● X-Y Mounting Y-axis transportable mass [kg]

		30 < G _n ≤ 50					
		Stroke [mm]					
X-axis: EZS6D Y-axis: EZS3D	Acceleration	50	100	150	200	250	300
	1.0 m/s ²	4.1	4.1	4.1	4.1	4.1	4.1
	2.5 m/s ²	3.3	3.3	3.3	3.3	3.3	3.3
	5.0 m/s ²	2.6	2.6	2.6	2.6	2.6	2.6

(3) Check the Speed of Linear Slides

Check the "speed – transportable mass characteristics" graph (Refer to page 66).

Draw a horizontal line for 3 kg mass in Y-axis.

The speed at which the acceleration 2.5 m/s² line intersects with the above-mentioned line is the maximum speed (upper limit) for dual axes combination.

- X-axis speed: 460 mm/s or less
- Y-axis speed: 560 mm/s or less

Speed and acceleration can be increased for the same mass, by replacing the power supply input with single-phase 100-115 VAC, 200-230 VAC and/or by using linear slides with greater size.

Speed – Transportable Mass

● X-Axis Speed

◇ 24 VDC

EZS6D□(M)-K

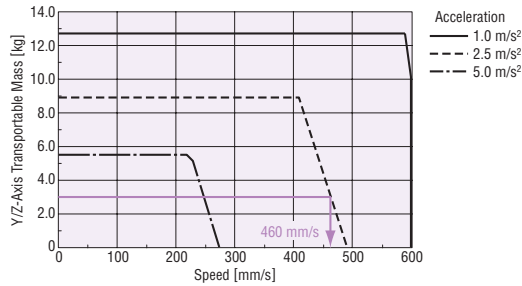

● Y-Axis Speed

◇ 24 VDC

EZS3D□(M)-K

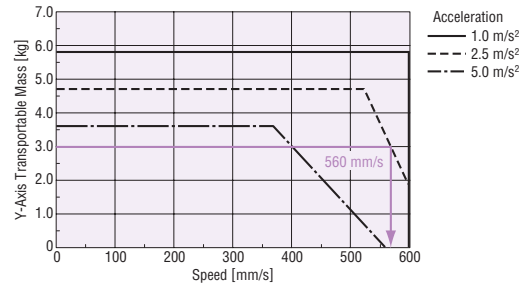

(4) Check the Positioning Time

Make a simple calculation of the positioning time to verify if your preferred positioning time can be met.

The simple formulas are as follows:

• Check the Operating Pattern

$$V_{Rmax} = \sqrt{L \cdot a \times 10^3}$$

L : Positioning distance [mm]
 a : Acceleration [m/s²]
 V_R : Operating speed [mm/s]
 V_{Rmax} : Maximum speed for triangular drive [mm/s]
 T : Positioning time [s]

$V_{Rmax} \leq V_R \rightarrow$ Triangular drive
 $V_{Rmax} > V_R \rightarrow$ Trapezoidal drive

• Calculate the Positioning Time

Triangular drive

$$T = \frac{2 \cdot V_{Rmax}}{a \times 10^3} \quad \text{or} \quad T = \sqrt{\frac{L}{a \times 10^3}} \times 2$$

Trapezoidal drive

$$T = \frac{L}{V_R} + \frac{V_R}{a \times 10^3}$$

● Example of Calculation

Check if the combination on page 64 can move 100 mm in 0.5 s.

X-axis: **EZS6D050-K**

Conditions
 Speed V_R : 460 mm/s
 Acceleration a : 2.5 m/s²
 Positioning distance L : 100 mm

Check the operating pattern

$$V_{Rmax} = \sqrt{100 \times 2.5 \times 10^3} = 500 > V_R \quad \text{Trapezoidal drive}$$

Calculate the positioning time

$$T = \frac{100}{460} + \frac{460}{2.5 \times 10^3} = 0.401 \text{ s}$$

Y-axis: **EZS3D025-K**

Conditions
 Speed V_R : 560 mm/s
 Acceleration a : 2.5 m/s²
 Positioning distance L : 100 mm

Check the operating pattern

$$V_{Rmax} = \sqrt{100 \times 2.5 \times 10^3} = 500 \leq V_R \quad \text{Triangular drive}$$

Calculate the positioning time

$$T = \frac{2 \times 100}{2.5 \times 10^3} = 0.400 \text{ s}$$

Calculation revealed that the preferred positioning time can be met.

Triangular drive

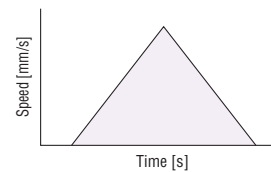

Trapezoidal drive

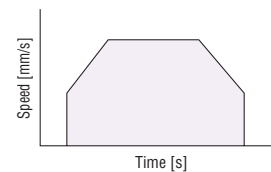

Transportable Mass per Acceleration

X-Y Mounting Y-axis transportable mass [kg]

	Acceleration	Gn ≤ 30 [mm]						30 < Gn ≤ 50 [mm]						50 < Gn ≤ 100 [mm]					
		Stroke [mm]						Stroke [mm]						Stroke [mm]					
		50	100	150	200	250	300	50	100	150	200	250	300	50	100	150	200	250	300
X-axis: EZS4D Y-axis: EZS3D	1.0 m/s ²	2.3	1.9	1.5	1.1	0.7	0.4	2.0	1.6	1.3	1.0	0.7	0.4	1.5	1.2	1.0	0.7	0.5	0.3
	2.5 m/s ²	1.3	0.9	0.6	0.2	—	—	1.1	0.8	0.5	0.2	—	—	0.8	0.6	0.4	0.2	—	—
	5.0 m/s ²	0.3	—	—	—	—	—	0.3	—	—	—	—	—	0.2	—	—	—	—	—
X-axis: EZS6D Y-axis: EZS3D	1.0 m/s ²	5.8	5.8	5.8	5.8	5.8	5.8	4.1	4.1	4.1	4.1	4.1	4.1	2.3	2.3	2.3	2.3	2.3	2.3
	2.5 m/s ²	4.8	4.8	4.8	4.8	4.8	4.8	3.3	3.3	3.3	3.3	3.3	3.3	1.9	1.9	1.9	1.9	1.9	1.9
	5.0 m/s ²	3.6	3.6	3.6	3.6	3.6	3.6	2.6	2.6	2.6	2.6	2.6	2.6	1.5	1.5	1.5	1.5	1.5	1.5
X-axis: EZS6D Y-axis: EZS4D	1.0 m/s ²	12.7	12.4	10.4	8.9	7.6	6.5	8.7	8.7	8.7	8.1	7.0	6.0	4.8	4.8	4.8	4.8	4.8	4.8
	2.5 m/s ²	10.1	9.8	8.2	6.9	5.8	4.9	7.0	7.0	7.0	6.3	5.3	4.5	3.9	3.9	3.9	3.9	3.9	3.8
	5.0 m/s ²	7.5	7.1	5.8	4.7	3.9	3.1	5.3	5.3	5.2	4.3	3.6	2.9	3.0	3.0	3.0	3.0	3.0	2.5

X-Z Mounting Z-axis transportable mass [kg]

	Acceleration	Gn ≤ 30 [mm]						30 < Gn ≤ 50 [mm]						50 < Gn ≤ 100 [mm]					
		Stroke [mm]						Stroke [mm]						Stroke [mm]					
		50	100	150	200	250	300	50	100	150	200	250	300	50	100	150	200	250	300
X-axis: EZS4D Z-axis: EZS3D	1.0 m/s ²	3.5	3.3	3.0	2.7	2.5	2.2	2.6	2.6	2.5	2.3	2.0	1.8	1.6	1.6	1.6	1.6	1.5	1.3
	2.5 m/s ²	2.1	1.7	1.4	1.0	0.7	0.4	1.7	1.4	1.2	0.9	0.6	0.4	1.2	1.0	0.8	0.7	0.5	0.3
	5.0 m/s ²	0.7	0.3	—	—	—	—	0.5	0.3	—	—	—	—	0.4	0.2	—	—	—	—
X-axis: EZS6D Z-axis: EZS3D	1.0 m/s ²	3.5	3.5	3.5	3.5	3.5	3.5	2.6	2.6	2.6	2.6	2.6	2.6	1.6	1.6	1.6	1.6	1.6	1.6
	2.5 m/s ²	3.1	3.1	3.1	3.1	3.1	3.1	2.3	2.3	2.3	2.3	2.3	2.3	1.4	1.4	1.4	1.4	1.4	1.4
	5.0 m/s ²	2.2	2.2	2.2	2.2	2.2	2.2	1.9	1.9	1.9	1.9	1.9	1.9	1.1	1.1	1.1	1.1	1.1	1.1
X-axis: EZS6D Z-axis: EZS4D	1.0 m/s ²	6.7	6.7	6.7	6.7	6.7	6.7	4.9	4.9	4.9	4.9	4.9	4.9	3.0	3.0	3.0	3.0	3.0	3.0
	2.5 m/s ²	5.9	5.9	5.9	5.9	5.9	5.9	4.3	4.3	4.3	4.3	4.3	4.3	2.6	2.6	2.6	2.6	2.6	2.6
	5.0 m/s ²	4.9	4.9	4.9	4.9	4.9	4.9	3.6	3.6	3.6	3.6	3.6	3.6	2.2	2.2	2.2	2.2	2.2	2.2

● Gn represents the distance from table to center of gravity of the work (unit: mm).

Speed – Transportable Mass Characteristics

X-Axis Speed (Common to electromagnetic brake type)

◇ 24 VDC

EZS4D□(M)-K

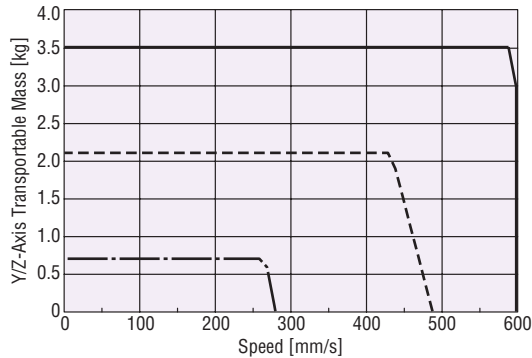

EZS6D□(M)-K

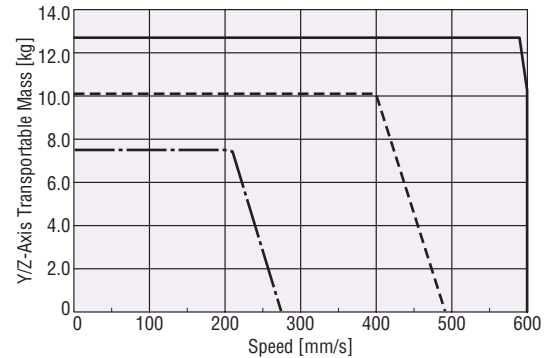

◇ Single-Phase 100-115 VAC/Single-Phase 200-230 VAC

EZS4D□(M)-A/EZS4D□(M)-C

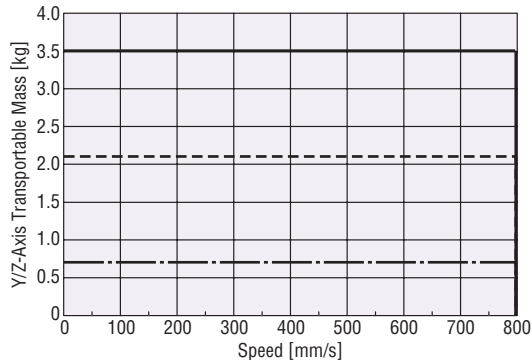

EZS6D□(M)-A/EZS6D□(M)-C

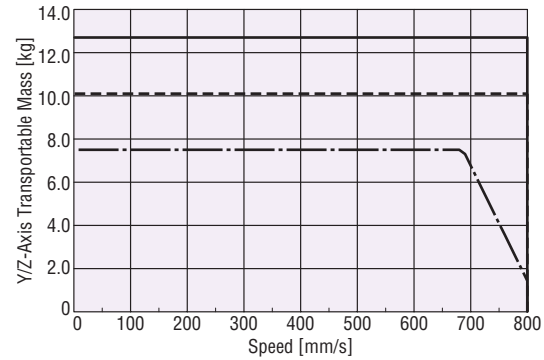

● Enter the stroke length in the box (□) within the model name.

● For X-axis, the maximum speed read from the graph is limited by the stroke. Check the maximum speed for each stroke in **EZSII** Series products.

● Y-Axis Speed (Common to electromagnetic brake type)

◇ 24 VDC

EZS3D□(M)-K

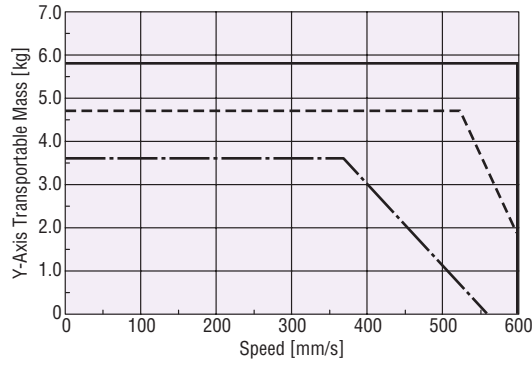

◇ Single-Phase 100-115 VAC/Single-Phase 200-230 VAC

EZS3D□(M)-A/EZS3D□(M)-C

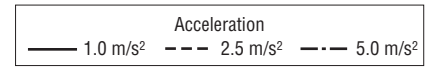
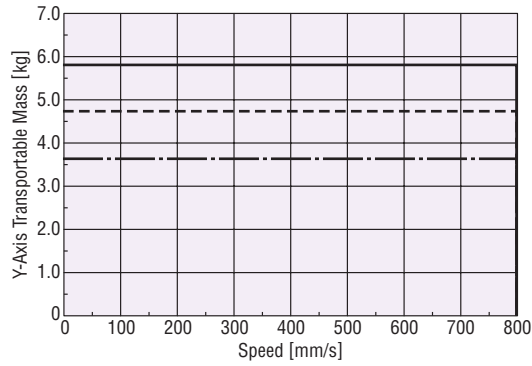

EZS4D□(M)-K

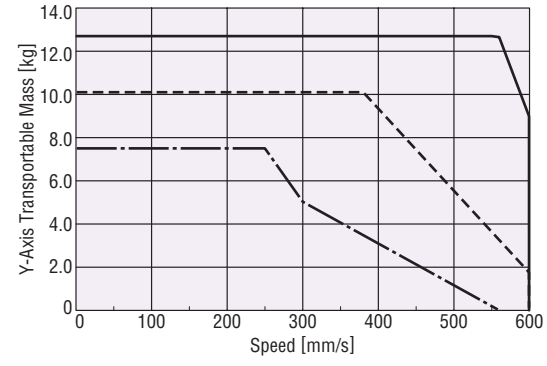

EZS4D□(M)-A/EZS4D□(M)-C

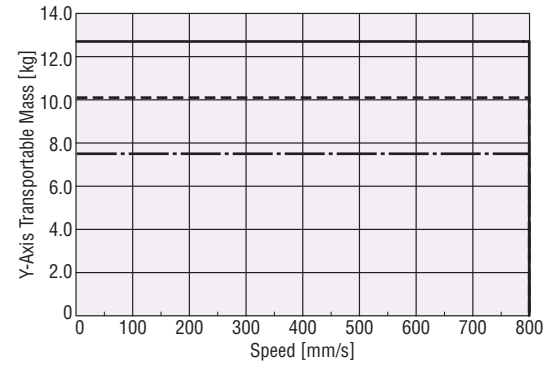

● Z-Axis Speed (Common to electromagnetic brake type)

◇ 24 VDC

EZS3D□(M)-K

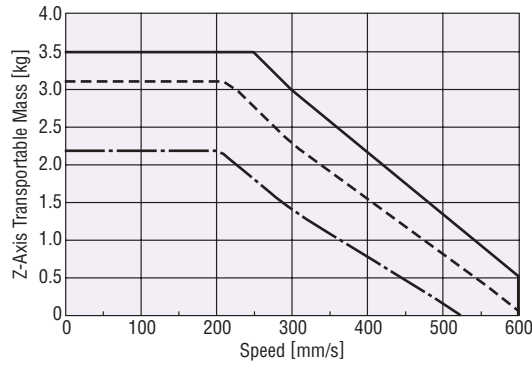

◇ Single-Phase 100-115 VAC/Single-Phase 200-230 VAC

EZS3D□(M)-A/EZS3D□(M)-C

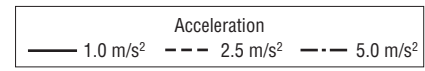
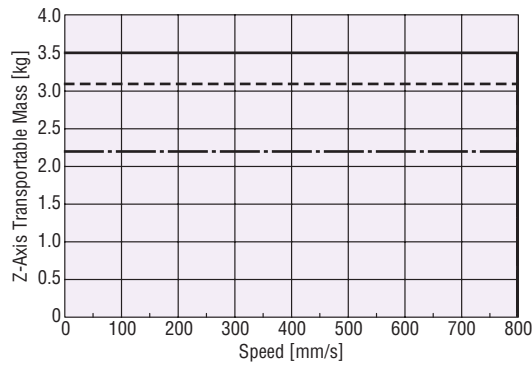

EZS4D□(M)-K

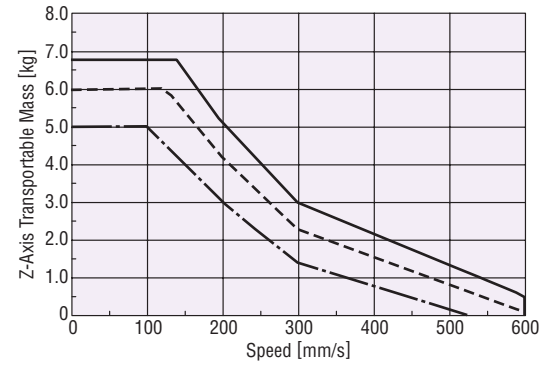

EZS4D□(M)-A/EZS4D□(M)-C

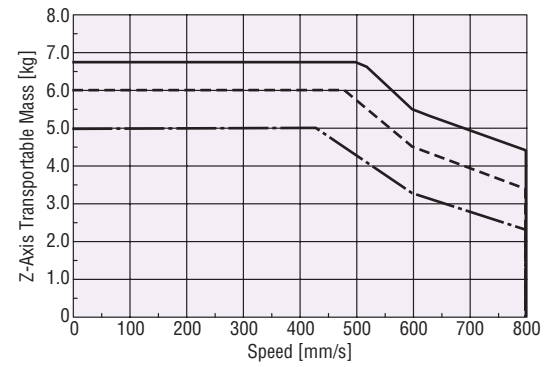

● Enter the stroke length in the box (□) within the model name.

This product is manufactured at a plant certified with the international standards **ISO 9001** (for quality assurance) and **ISO 14001** (for systems of environmental management).

Specifications are subject to change without notice.

This catalogue was published in Apr, 2008.

ORIENTAL MOTOR U.S.A. CORP.

Western Sales and Customer Service Center

Tel: (310) 715-3301 Fax: (310) 225-2594

Los Angeles

Tel: (310) 715-3301

San Jose

Tel: (408) 392-9735

Midwest Sales and Customer Service Center

Tel: (847) 285-5100 Fax: (847) 843-4121

Chicago

Tel: (847) 285-5100

Dallas

Tel: (214) 432-3386

Toronto

Tel: (905) 502-5333

Eastern Sales and Customer Service Center

Tel: (781) 848-2426 Fax: (781) 848-2617

Boston

Tel: (781) 848-2426

Charlotte

Tel: (704) 696-1036

New York

Tel: (973) 359-1100

Technical Support

Tel: (800) 468-3982 / 8:30 a.m. to 5:00 p.m., P.S.T. (M-F)

7:30 a.m. to 5:00 p.m., C.S.T. (M-F)

E-mail: techsupport@orientalmotor.com

Obtain Specifications, Online Training

and Purchase Products at:

www.orientalmotor.com