



# EZ limo

## — Easy to use linear motion

*Oriental Motor began by thinking from the user's point of view and a commitment to do whatever it takes to achieve what our users have requested. Oriental Motor then combined a number of advanced functions needed to obtain the high level of easy to use functionality that the **EZ limo** series includes today. Oriental Motor also worked to create a visual design that has never been seen in a factory automation environment. Based on the principles of making a product that was both easy to use and pleasing to look at, Oriental Motor is pleased to introduce the **EZ limo** series of linear motion products.*



# Easy to Use

### EZlimo: Series Line-Up

- 
  - Motorized Linear Slides
    - **EZS Series**
    - **EZHS Series**
  - Motorized Cylinders
    - **EZC Series**
    - **EZHC Series**
    - **EZHP Series**



# Index

## LIMO

<b>Features</b>	4~5
<b>Functions</b>	6~9
<b>Selection</b>	10~11
<b>Line-Up · Conformance with EC Directives/Safety Standards and CE Marking</b>	12~15
<b>System Configuration</b>	16~19
<b>Motorized Linear Slides</b>	20~35
<b>Motorized Cylinders</b>	36~51
<b>Controller</b>	52~55
<b>Connection Diagrams</b>	56~61
<b>Installation</b>	62~64
<b>Optional Parts</b>	65~73
<b>Linear Motion Products</b>	74~75

## Employing Ideals that are Distinctive to Oriental Motor

**EZ limo** is a linear-motion system that combines Oriental Motor's pledge of "ultimate user-friendliness", "utilization of the latest motor technology", "pursuit of mechanical design excellence" and "consideration for safety and the environment".

### Motorized Linear Slides

**EZS Series**

**EZHS Series**

Fastest



### Motorized Cylinders

**EZC Series**

**EZHC Series**

**EZHP Series**

Fastest

Highest Thrust



## Useful

### Ultimate User-Friendliness

#### ●Offering a Wide Range of Utilities

Up to 63 motion profiles can be set. The system provides a full range of utilities such as a teaching function, push function, area output function, selection of home detection modes and absolute feedback type. **EZ limo** also supports external pulse input, which means you can combine your existing controller with the **EZ limo** system.

#### ●Pleasant, User-Friendly Operation

An optional teaching pendant facilitates data setting and operation. The LCD monitor is easy to see, and the user-friendly controls ensure pleasant, trouble-free operation.



You can set or edit various data on your personal computer using optional data editing software.

## Technical

### Incorporating Proprietary Technologies from Oriental Motor, an Industry Leader

#### ●New Closed-Loop Control

The motor part houses a stepping motor with a position feedback device. When a condition presenting the possibility of a misstep is detected, the motor performs closed-loop control, thereby ensuring stable operation.

#### ●Prevention of Hunting at Standstill

Unlike conventional servomotors, the motor used in the **EZ limo** system is free from hunting.

#### ●Low Vibration/Low Noise Even During Low-Speed Operation

The new **EZHS/EZHC/EZHP** series adopts a software-based smooth drive control to suppress vibration and noise even during low-speed operation, such as the return-to-home operation.

## Mechanical

### Pursuit of Mechanical Design Excellence

#### ●Easy Combination of Multiple Axes

If necessary, such as when palletizing the work, two axes can be combined using an optional dual axis mounting bracket. X-Y configuration (4 patterns) and X-Z configuration (4 patterns) can be implemented with ease.



Installation example:  
X-Y configuration



Installation example:  
X-Z configuration

#### ●Maintenance-Free for Long-Term Performance

The drive mechanism uses THK's ball screw, while the guide mechanism adopts THK's LM Guide®.

The ball screw employs the QZ™ lubrication system, while the LM Guide® uses the Ball Retainer® to retain the coupled rolling elements. These mechanisms give the system a considerable duration of maintenance-free performance.

\* QZ™ lubrication system (THK): High-density fiber net supplies appropriate amounts of oil, thereby preventing oil wastage and reducing environmental burden.

\* Ball Retainer®(THK): Individual balls are retained in a manner allowing smooth rotation while preventing contact with adjacent balls. Use of the Ball Retainer® provides long-term, maintenance-free operating conditions and other benefits.

\* Ball Retainer and LM Guide are registered trademarks of THK Co., Ltd.

#### ●Thin, Compact Linear Slide

The linear slide is only 31.5 mm high (**EZS4·EZHS4**). The ultra thin body helps save space at the installation site.



## Safety

### Consideration for Safety and the Environment

#### ●Environmentally Friendly

The **EZ limo** system is constructed from carefully selected parts that exert a minimum burden on the environment.

#### ●UL/CSA Standards

The **EZHS/EZHC/EZHP** series adopt a motor and controller certified by UL/CSA standards.

#### ●CE Marking

All **EZ limo** products bear the CE mark to indicate their conformance with the Low-Voltage and EMC directives.

\* See "Conformance with EC Directives" on p.13 & p.15 for details.



## EZ limo : The Ultimate Combination of User-Friendliness, High Reliability and High Functionality

Common

### Space-Saving Cable Outlet Orientation

The cable outlet is facing downward, which contributes to the overall space savings by reducing the space needed to wire the cables.



EZS EZHS

### Positioning Pinholes on the Table

These holes help maintain positional repeatability when the work must be removed and then installed again for the purpose of maintenance, etc.

EZS EZHS

### Stainless Sheet

The mechanical parts of the linear slide are covered with a stainless sheet to keep out foreign particles.  
(The stainless sheet is also available as a spare part.)

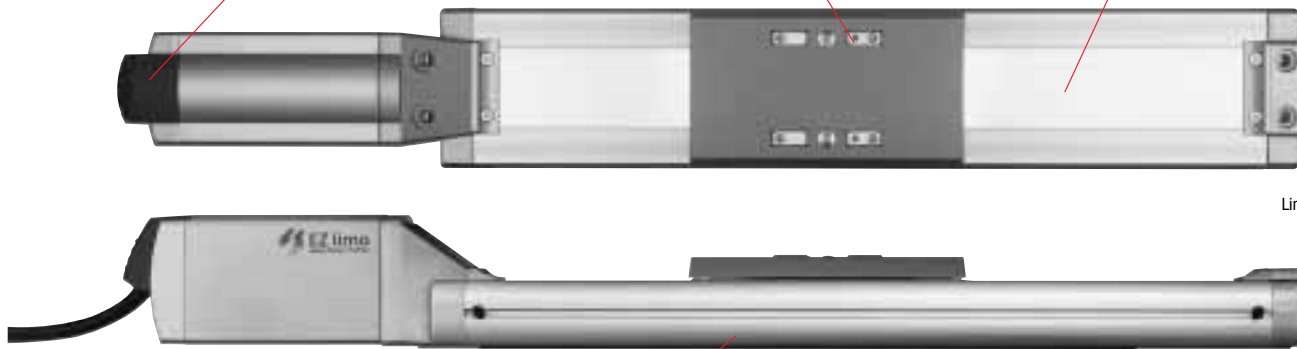

Linear slide height  
31.5 mm  
**EZS4**  
**EZHS4**

Common

### Drive method : THK's ball screw

(The QZ™ lubrication system provides a considerable duration of maintenance-free performance.)

EZS EZHS

### Guide mechanism: THK's LM Guide®

(Ball Retainer® provides long-term, maintenance-free operating conditions.)

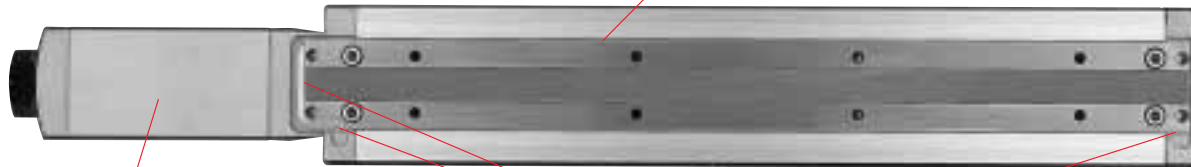

Common

### Easy Connection

A connector provides a simple, one-touch connection to the controller.  
A power cable is also supplied for ease of connection.

EZS EZHS

### Mounting Reference Surface

These surfaces help maintain positional repeatability when the linear slide must be removed and then installed again for the purpose of maintenance, etc.

Common

### Easy Installation

Both the mechanical parts and controller can be installed easily.

**Linear Slide:** The linear slide body can be affixed directly from the top and bottom with screws.  
(EZS3 and EZHS3 can be affixed only from the bottom.)

**Cylinder:** The cylinder can be installed through the dedicated mounting holes, or via a flange connection using an optional mounting bracket.

**Controller:** The EZS/EZC series controllers can be installed with mounting screws or using a DIN rail. The EZHS/EZHC/EZHP series controllers come with dedicated mounting brackets.

\* See p.62 to p.64 for details on the installation.

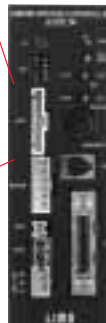

Common

### Real-Time Monitoring

Information such as set data, current position and I/O status can be monitored in real time using an optional teaching pendant (sold separately).



**Choice of Incremental Type or Absolute Type Feedback** Common

As long as power is supplied, the **EZ limo** system can proceed to the next operation without executing home detection, even given the occurrence of an overload or emergency stop error.

Choose the incremental type if you want to execute home detection each time the power is turned on. The absolute type would be your choice if you want to start operation from the current position rather than the home position, when the power is turned on.

**Absolute Type**

The absolute type allows the movement of the table or rod to be followed and backed up, even when the power is cut off.

**●EZS/EZC Series**

Two types of backup modes are available. Select the mode that best suits your application.

- Standard backup — Provides a longer backup period
- Optional backup — Provides better speed-follow-up capability

**●EZHS/EZHC/EZHP Series**

These models provide a long backup period of around 15 days (approx. 360 hours).

**Teaching Function** Common

You can move the table to a desired position manually or by using the teaching pendant and store that position.

**●Direct Teaching:**

Turn off the excitation of the motor and move the table or rod manually to the target position, then store that position in the motion profile.

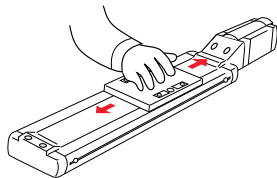

Direct teaching

**●Remote Teaching:**

Use the keys on the teaching pendant to move the table or rod to the target position, then store that position in the motion profile.

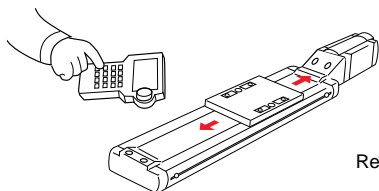

Remote teaching

**Choice of Home Detection Methods** Common

You can choose the sensorless mode if you want to simplify the mechanical layout, or the sensor mode if you want to use sensors to detect home.

**●Sensorless Home Detection**

Home detection is performed without the use of a home sensor. The home position can be adjusted. For the linear slides, the direction of home detection can also be changed.

**●Home Detection Using Sensors**

Home detection is performed using home sensors. The sensors are available as options. (See p. 68 for the sensor set.)

**Operation Using External Pulse Input** Common

The **EZ limo** can be combined with your existing controller to serve as a driver.

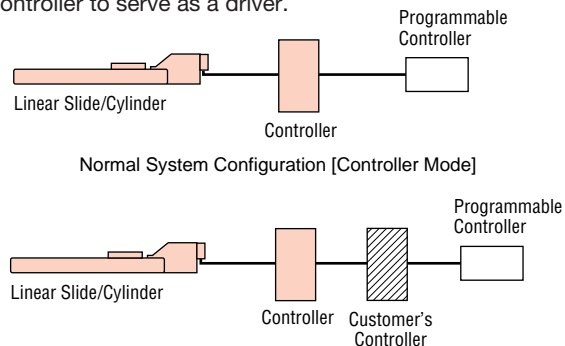

When Combined with the Customer's Controller [Driver Mode]

	Controller Mode	Driver Mode
Push Function	●	×
Teaching Function	●	×
Monitoring Function	●	×
Pause Function *1	●	×
Area Output Function	●	×
Absolute Type	●	●*2
Sensorless Home Detection	●	×

● = Available    × = Not available

Notes:

- Certain functions cannot be used in the driver mode.
- Provide HOME, +LS and -LS sensors (optional) and connect them to the controller you want to use.

\*1 Only for **EZS** and **EZC** Series

\*2 Only for **EZHS**, **EZHC** and **EZHP** Series

**Push Function** EZE EZHC EZHP

The rod can be held in a state of being pushed against the work or similar object, as with an air cylinder.

The force used to push the work (push force) can be changed. The **EZHC/EZHP** series handles up to 63 push width/force profiles.

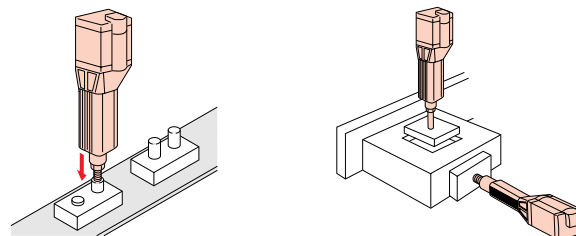

## Area Output Function

Common

A signal is output when the linear slide table or cylinder rod enters a set range during operation.

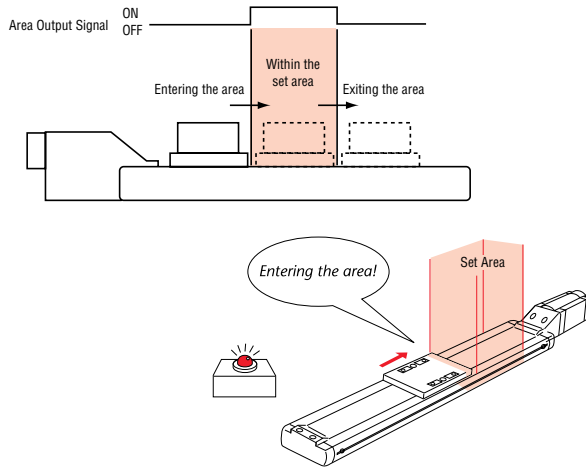

## Easy Data Editing

EZS EZC

You can set and edit various data on a personal computer (PC) using the optional data editing software. The software comes with a PC interface cable (five meters in length) used to connect the controller and PC. The software also provides various monitoring functions.

\* See p.16 and p.65 for details.

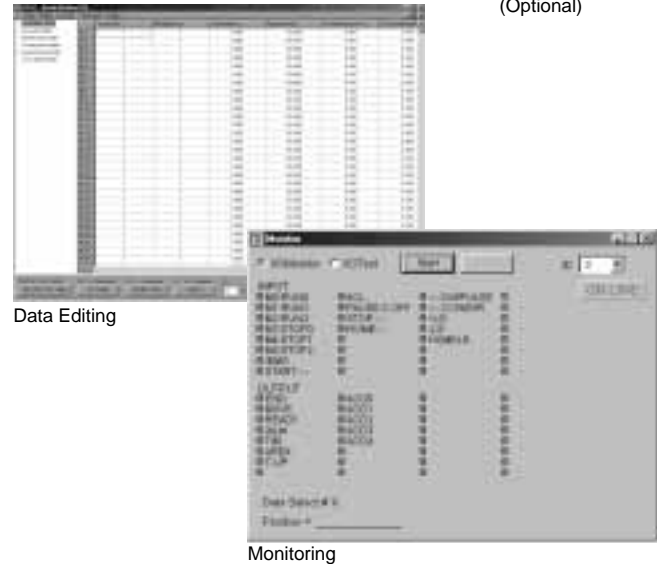
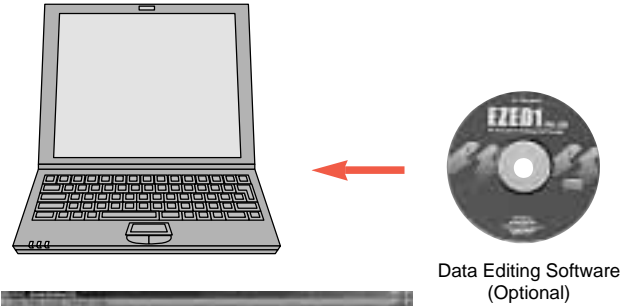

## Pause Function

EZS EZC

The linear slide/cylinder can be stopped temporarily during operation, using an external signal. When the pause input signal (PAUSE) is turned ON, the linear slide/cylinder decelerates to a stop. When the START signal is turned ON again after the (PAUSE) signal is turned OFF, the linear slide/cylinder resumes operation from the position at which it had stopped.

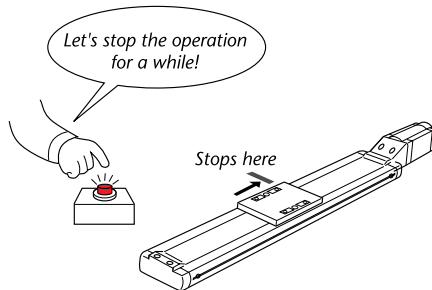

## Connection of Multiple Axes

Common

A maximum of 16 controllers can be connected, with data set separately for each of the controllers. There is no need to connect the teaching pendant to each of the controllers.

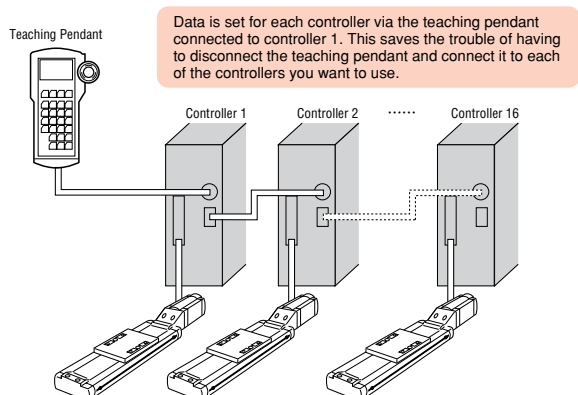

## Multifunction Controller (Stored-Data Type)

### ● A Maximum of 63 Motion Profiles

Common

Up to 63 motion profiles can be set by the controller.

### ● Two Motion Profile Setting Modes: Absolute Mode and Incremental Mode

Common

You can set motion profiles in the absolute mode or incremental mode, depending on your preferred movement of the equipment.

#### Absolute Mode (Absolute-Position Specification) :

Each position is set as the absolute position with respect to the reference point. This is suitable when you want to move the work directly from an arbitrary position to the specified position.

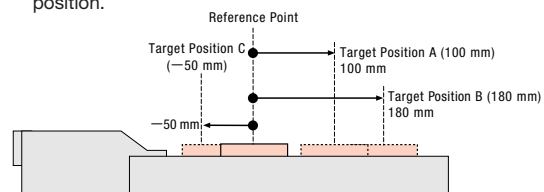

### Incremental Mode (Relative-Position Specification) :

Each position is relative, being set as an amount of travel from the current position or another target position for the work. This is suitable in a regular feed or other operation where the same pattern is used repeatedly.

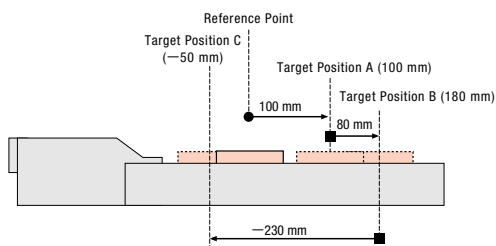

### Simple Unit Setting

Common

Travel amount, operating speed and acceleration/deceleration can be set directly as mm, mm/s and m/s<sup>2</sup> values, respectively. There is no need for pulse conversion, which allows for more efficient operation of a linear-motion product.

### Continuous Operation via External Signal EZHS EZHC EZHP

Continuous operation can be performed while an external signal (FWD, RVS) is ON. This mode is ideal when you want to move the work via external control without using the teaching pendant.

### Output of Current Position and Error Code EZHS EZHC EZHP

The current position, error code and certain other data can be output to an external device.

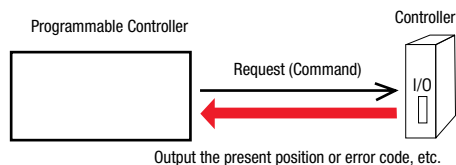

### Table/Rod Position Monitor EZHS EZHC EZHP

A counter or similar device can be connected to monitor the position of the linear slide table or cylinder rod using phase-A/B pulse signal outputs.

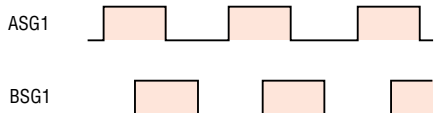

(When the slider table or cylinder rod is moving to the counter-motor side)

#### Notes:

- The phase difference between A and B is 90° electrical.
  - The pulse output accuracy is within ±0.01 mm.
  - Pulse output is subject to a maximum delay of 1 ms with respect to the actual movement of the linear slide table or cylinder rod.
- Use this function to check the stop position.
- Pulse output is possible at up to the maximum operating speed of each series. When counting the number of pulses, use a frequency counter that can count frequencies of at least twice the frequency level of the applicable maximum speed.

Maximum speed and frequency  
**EZHS** Series : 800 mm/s (80 kHz)  
**EZHC** Series : 600 mm/s (60 kHz)  
**EZHP** Series : 300 mm/s (60 kHz)

- When a line-driver output is used, connect a 150 Ω terminal resistor between the line-receiver inputs.
- When an open-collector output is used, keep the cable length to 2 m or shorter. With an open-collector output, the output waveform changes depending on the load condition. Check the operation of the connected equipment.

### Two Data Execution Modes: Selective Positioning and Sequential Positioning Common

#### Selective positioning mode:

The set data can be selected at random.

#### Sequential positioning mode:

Positioning operations are performed sequentially from the desired data.

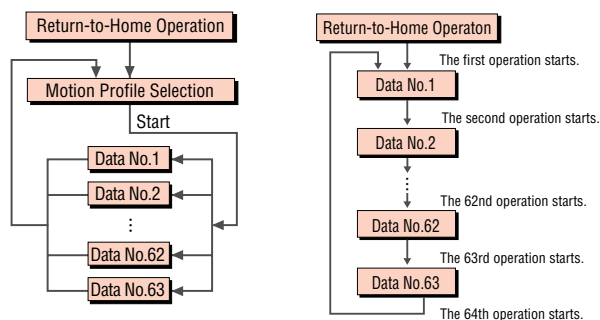

### Separate Acceleration and Deceleration Settings Common

Acceleration and deceleration can be set separately for each motion profile. This feature is useful in a quick acceleration/slow deceleration operation where the motor rises quickly and then decelerates slowly to a stop. [The opposite pattern (slow acceleration/quick deceleration) is also supported.]

**EZS/EZC** Series: Each motion profile has its own acceleration and deceleration settings.

**EZHS/EZHC/EZHP** Series: One common acceleration and deceleration setting for all motion profiles

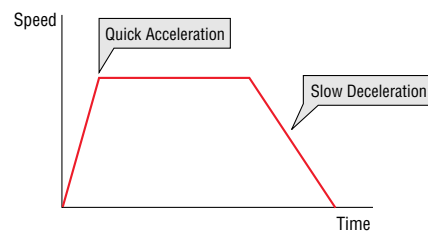

### Linked Operation Common

Up to 63 motion profiles (for **EZS/EZC** Series) or 4 motion profiles (for **EZHS/EZHC/EZHP** Series) can be linked, thereby allowing the motor to change speeds without stopping.

**Note:** The motion profiles must create a motion in the same direction in order to be linked.

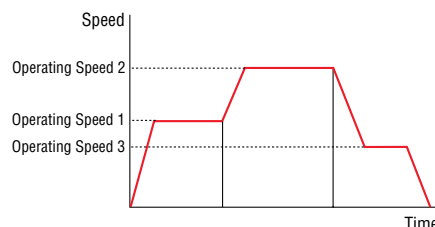



To select an **EZ limo** product that best suits your application, check the required specifications using the following procedure:

[1] Check the required operation.

[2] Check the direction of installation.

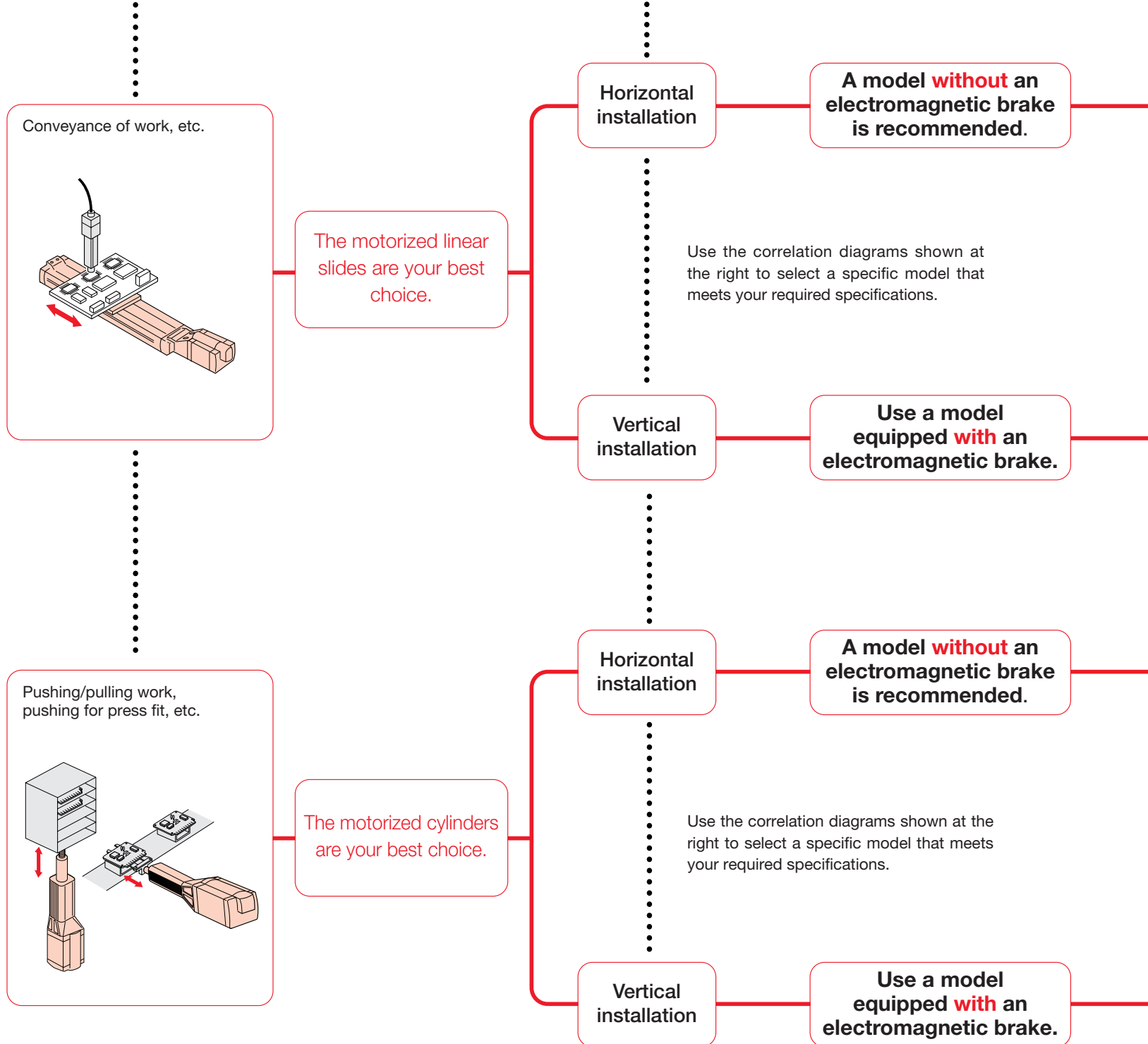

Correlation of Speed and Load Weight for Linear Slide Horizontal Direction

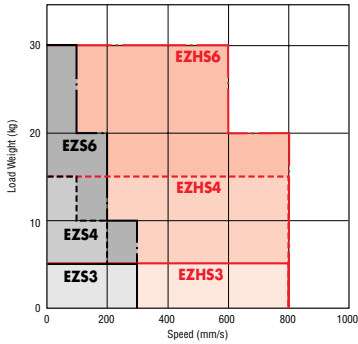

Correlation of Speed and Load Weight for Linear Slide Vertical Direction

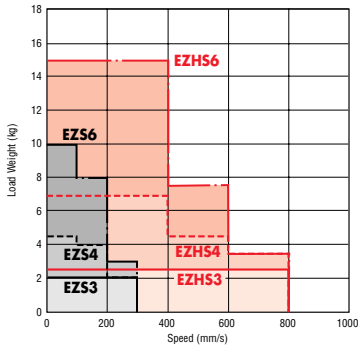

Correlation of Speed and Thrust Force for Cylinder Horizontal Direction

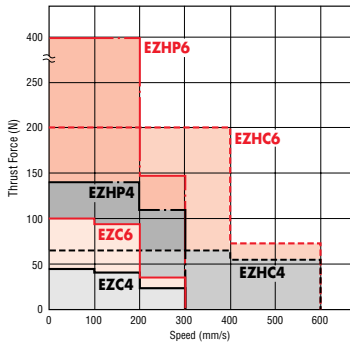

Correlation of Speed and Thrust Force for Cylinder Vertical Direction

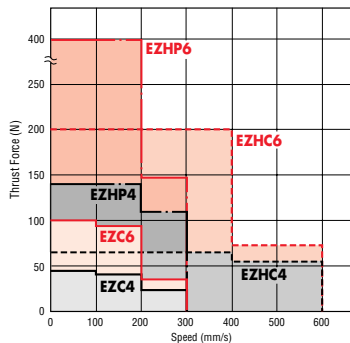

Correlation of Speed and Load Weight for Cylinder Vertical Direction

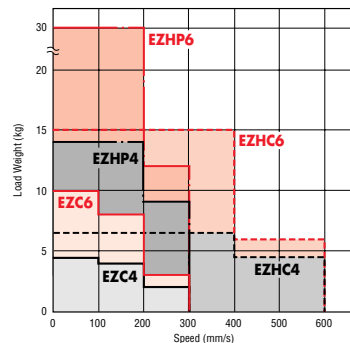

## Motorized Linear Slides EZS Series



### EZHS Series

Line-Up ..... Page 12~15

**EZS** Series Specifications & Characteristics ..... Page 24~29

**EZHS** Series Specifications & Characteristics ... Page 30~35

Note: If the object to be installed to the linear slides has a large overhung from the center of the table, consider the length of overhung.  
(See the allowable overhung lengths specified on p. 24 to p. 34.)

## Motorized Cylinders EZC Series



### EZHC Series EZHP Series

Line-Up ..... Page 12~15

**EZC** Series Specifications & Characteristics ..... Page 40~43

**EZHC** Series Specifications & Characteristics ... Page 44~47

**EZHP** Series Specifications & Characteristics ... Page 48~51

## Motorized Linear Slides

### EZS Series

Model	Power Supply	Electromagnetic Brake	Type	Stroke mm	Maximum Speed mm/s	Max. Transportable Mass kg		Max. Thrust Force N	CE Marking	Page	
						Horizontal Direction	Vertical Direction				
<b>EZS3-□CI</b>	24 VDC	Not equipped	Incremental	50 100 150 200	300	5	—	23	○	24	
<b>EZS3-□CA</b>			Absolute								
<b>EZS3-□MCI</b>		Equipped	Incremental								
<b>EZS3-□MCA</b>			Absolute								
<b>EZS4-□CI</b>		Not equipped	Incremental		250 300 400 500	100	15	—			45
<b>EZS4-□CA</b>			Absolute			200	10	—			40
<b>EZS4-□MCI</b>		Equipped	Incremental	300		5	—	23			
<b>EZS4-□MCA</b>			Absolute	100		15	4.5	45			
<b>EZS6-□CI</b>		Not equipped	Incremental	100 150 200 250		200	10	—		94	
<b>EZS6-□CA</b>			Absolute			300	5	—		23	
<b>EZS6-□MCI</b>		Equipped	Incremental		100	30	—	100			
<b>EZS6-□MCA</b>			Absolute		150	20	—	94			
			200		10	—	35				
			250		100	30	10	100			
			300	200	20	8	94				
			400	300	10	3	35				

\*The box in the model name represents the code for stroke length.

## Motorized Cylinders

### EZC Series

Model	Power Supply	Electromagnetic Brake	Type	Stroke mm	Maximum Speed mm/s	Max. Transportable Mass kg		Max. Thrust Force N	CE Marking	Page	
						Horizontal Direction	Vertical Direction				
<b>EZC4-□CI</b>	24 VDC	Not equipped	Incremental	50 100 200 300	100	—	—	45	○	40	
<b>EZC4-□CA</b>			Absolute		200	—	—	40			
<b>EZC4-□MCI</b>		Equipped	Incremental		100	—	4.5	45			
<b>EZC4-□MCA</b>			Absolute		200	—	4	40			
<b>EZC6-□CI</b>		Not equipped	Incremental		100 200 300	300	—	2			23
<b>EZC6-□CA</b>			Absolute			100	—	—			100
<b>EZC6-□MCI</b>		Equipped	Incremental	200		—	—	94			
<b>EZC6-□MCA</b>			Absolute	300		—	—	35			
				100		—	10	100			
				200		—	8	94			
				300	—	3	35				

\*The box in the model name represents the code for stroke length.

### ■ Conformance with EC Directives (EZS and EZC series)

The linear slides, cylinders, controllers and teaching pendant bear the CE mark to indicate their conformance with the EMC directives.

#### ● Compliance Conditions

- Incorporation in equipment
- Overvoltage Category: I
- Pollution Degree: Class 2
- Class III equipment

#### ● EMC Directives (89/336/EEC, 92/31/EEC)

See the instructions in the "**EZS/EZC Series Controller User Manual**" for the installation and wiring methods.

#### ◇ Applicable Standards

- EMI Emission Tests:
 

EN 50081-2
Radiated Emission Test: EN 55011
- EMS Immunity Tests:
 

EN 61000-6-2
Radiation Field Immunity Test: IEC 61000-4-3
Electrostatic Discharge Immunity Test: IEC 61000-4-2
Fast Transient/Burst Immunity Test: IEC 61000-4-4
Conductive Noise Immunity Test: IEC 61000-4-6

#### ● Emergency Stop

The emergency stop function cuts off the motor current, leaving the motor in a free state.

#### ◇ Emergency Stop Function

The stop action actuated by the emergency stop switch or EMG input conforms to "Stop Category 0 (non-controlled stop)" under EN 60204-1.

#### ◇ Emergency Stop Circuit

The safety parts in the emergency stop circuit are selected in accordance with the requirements of EN 954-1, category 1.



## Motorized Linear Slides **EZHS** Series

Model	Power Supply Single-Phase	Electromagnetic Brake	Type	Stroke mm	Maximum Speed mm/s	Max. Transportable Mass kg		Max. Thrust Force N	CE Marking	Page
						Horizontal Direction	Vertical Direction			
<b>EZHS3A-□I</b>	100-115V	Not equipped	Incremental	50 100 150 200	800	5	—	30	×	30
<b>EZHS3A-□A</b>			Absolute							
<b>EZHS3A-□MI</b>		Equipped	Incremental							
<b>EZHS3A-□MA</b>			Absolute							
<b>EZHS4A-□I</b>		Not equipped	Incremental	250	400	15	—	70		32
<b>EZHS4A-□A</b>				Absolute						
<b>EZHS4A-□MI</b>		Equipped	Incremental	300	600	15	—	55		
<b>EZHS4A-□MA</b>				Absolute						
<b>EZHS4A-□MI</b>	Equipped	Incremental	400	800	15	7	70			
<b>EZHS4A-□MA</b>			Absolute							
<b>EZHS4A-□MA</b>	Equipped	Incremental	500	800	15	4.5	55			
<b>EZHS4A-□MA</b>			Absolute							
<b>EZHS6A-□I</b>	100-115V	Not equipped	Incremental	100 150	400 600	30 30	— —	184 92	○	34
<b>EZHS6C-□I</b>	200-230V		Absolute							
<b>EZHS6A-□A</b>	100-115V	Equipped	Incremental	200 250 300	400 600	30 30	15 7.5	184 92		
<b>EZHS6A-□MI</b>	100-115V									
<b>EZHS6A-□MI</b>	200-230V	Equipped	Incremental	400 500	400 600	30 30	15 7.5	184 92		
<b>EZHS6A-□MA</b>	100-115V									Absolute
<b>EZHS6A-□MA</b>	200-230V	Equipped	Incremental	400 500	800	20	3.5	50		
<b>EZHS6C-□MA</b>	200-230V									Absolute

\*The box in the model name represents the code for stroke length.

## Motorized Cylinders **EZHC** Series

Model	Power Supply Single-Phase	Electromagnetic Brake	Type	Stroke mm	Maximum Speed mm/s	Max. Transportable Mass kg		Max. Thrust Force N	CE Marking	Page
						Horizontal Direction	Vertical Direction			
<b>EZHC4A-□I</b>	100-115V	Not equipped	Incremental	50 100 200 300	400 600	— —	— —	65 55	×	44
<b>EZHC4A-□A</b>			Absolute							
<b>EZHC4A-□MI</b>		Equipped	Incremental							
<b>EZHC4A-□MA</b>			Absolute							
<b>EZHC6A-□I</b>	100-115V	Not equipped	Incremental	50 100 200 300	400 600	— —	— —	200 73	○	46
<b>EZHC6C-□I</b>	200-230V		Absolute							
<b>EZHC6A-□A</b>	100-115V	Equipped	Incremental		400 600	— —	15 6	200 73		
<b>EZHC6A-□MI</b>	100-115V									
<b>EZHC6A-□MI</b>	200-230V	Equipped	Incremental	400 600	— —	15 6	200 73			
<b>EZHC6A-□MA</b>	100-115V							Absolute		
<b>EZHC6A-□MA</b>	200-230V	Equipped	Incremental	400 600	— —	15 6	200 73			
<b>EZHC6C-□MA</b>	200-230V							Absolute		

\*The box in the model name represents the code for stroke length.

## Motorized Cylinders **EZHP** Series

Model	Power Supply Single-Phase	Electromagnetic Brake	Type	Stroke mm	Maximum Speed mm/s	Max. Transportable Mass kg		Max. Thrust Force N	CE Marking	Page
						Horizontal Direction	Vertical Direction			
<b>EZHP4A-□I</b>	100-115V	Not equipped	Incremental	50 100 200 300	200 300	— —	— —	140 110	×	48
<b>EZHP4A-□A</b>			Absolute							
<b>EZHP4A-□MI</b>		Equipped	Incremental							
<b>EZHP4A-□MA</b>			Absolute							
<b>EZHP6A-□I</b>	100-115V	Not equipped	Incremental	50 100 200 300	200 300	— —	— —	400 147	○	50
<b>EZHP6C-□I</b>	200-230V		Absolute							
<b>EZHP6A-□A</b>	100-115V	Equipped	Incremental		200 300	— —	30 12	400 147		
<b>EZHP6C-□A</b>	200-230V									
<b>EZHP6A-□MI</b>	100-115V	Equipped	Incremental	200 300	— —	30 12	400 147			
<b>EZHP6A-□MA</b>	100-115V							Absolute		
<b>EZHP6A-□MA</b>	200-230V	Equipped	Incremental	200 300	— —	30 12	400 147			
<b>EZHP6C-□MA</b>	200-230V							Absolute		

\*The box in the model name represents the code for stroke length.



## ■ Safety Standards and CE Marking (EZHS/EZHC/EZHP series)

### ● UL/CSA Standards

The **EZHS/EZHC/EZHP** series adopt a motor and controller certified by the UL/CSA standards.

The motors and controllers are certified under the model names listed below.

Model	Certified Products	Standards	Certification Body	File No.
<b>EZHS3A</b> -□□	Motor (Built into linear slide/cylinder)	EZHM46AA	UL 1004, UL 2111	UL E64199
<b>EZHS4A</b> -□□		EZHM46MA *2		
<b>EZHC4A</b> -□□	Controller	EZMC13I-A	UL 508C *1 CSA C22.2 No.14	UL E171462
<b>EZHP4A</b> -□□		EZMC13A-A		
<b>EZHS6</b> □□□	Motor (Built into linear slide/cylinder)	EZHM66A	UL 1004, UL 2111 CSA C22.2 No.100 CSA C22.2 No.77	UL E64199
<b>EZHC6</b> □□□		EZHM66MA *2		
<b>EZHP6</b> □□□		EZHM66AC *2 *3		
		EZHM66MC *2 *3		
	Controller	EZMC24I-A	UL 508C *1 CSA C22.2 No.14	UL E171462
		EZMC24A-A		
		EZMC12I-C		
		EZMC12A-C		

\*1 For UL standard (UL 508C), the product is recognized for the condition of Maximum Surrounding Air Temperature 40°C.

\*2 With electromagnetic brake

\*3 200 VAC input

- The teaching pendant is not certified by the UL standards.

### ● CE Marking

Product	CE Marking
Linear slide	Low Voltage directive
Controller	EMC directive

The EMC value changes according to the wiring and layout. Therefore, the final EMC level must be checked with the motor/driver incorporated in the user's equipment.

If you require EMC data of Linear Slides or Controllers, please contact your nearest Oriental Motor office.

### ◇ Machinery Directive (98/37/EC)

The linear slides, cylinders, controllers and teaching pendants are designed and manufactured for use in general industrial equipment as an internal component, and therefore need not comply with the Machinery Directive. However, each product has been evaluated under the following standards to ensure proper operation:

EN 292-1, EN 292-2, EN 954-1, EN 418, EN 60204-1

#### • Emergency Stop Function

The emergency stop button of the teaching pendant uses an EN-certified product. See page 58 for a connection example that conforms to Stop Category 0 (non-controlled stop) under EN 60204-1.

#### • Emergency Stop Circuit

The safety parts in the emergency stop circuit are selected in accordance with the requirements of EN 954-1.

### ■ If you already have a teaching pendant;

Please check its conformance to EC Directives on the nameplate attached on the back of the teaching pendant.

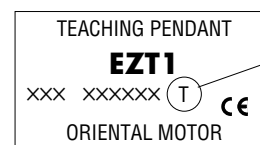

T : Conforming to the Low-Voltage and EMC Directives

J : Conforming to only the EMC Directives

If the nameplate on your teaching pendant shows "J" and your application requires conformance to the Low-Voltage Directives, purchase a new teaching pendant that ensures the required conformance.

■ **EZS Series · EZC Series**

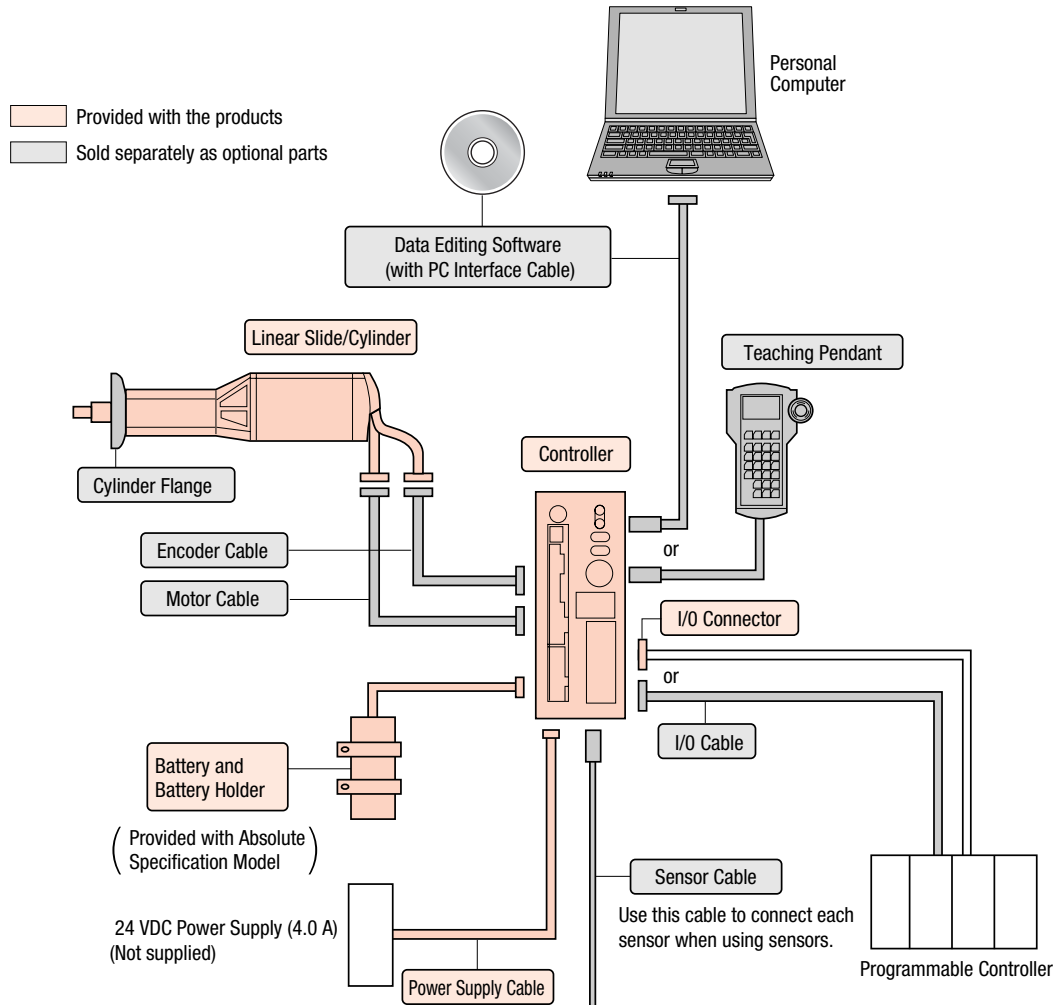

■ **Optional Parts (sold separately)**

- EZS For use with the **EZS** series
- EZC For use with the **EZC** series

● **Teaching Pendant** — EZS EZC — P.65

The teaching pendant allows you to set and execute motion profiles already stored, as well as to monitor the set data, current position and I/O status in real time.



● **Data Editing Software** — EZS EZC — P.65

With this software you can set and edit various data on a PC. It comes with a PC interface cable for connecting the controller and PC. The software also provides various monitoring functions.



● **Cable Set** — **EZS** **EZC** — P.66

A set of dedicated cables is used to connect the **EZ limo** linear slide/cylinder with the controller. The cable set consists of a motor cable and an encoder cable. The cable length can be selected from 2 m, 5 m and 10 m. Each of the cables can be purchased individually.



Motor cable



Encoder cable

● **Controller Link Cable** — **EZS** **EZC** — P.67

Use this dedicated cable to link the **EZ limo** controllers. A maximum of 16 controllers can be connected, with data set separately for each of the controllers.

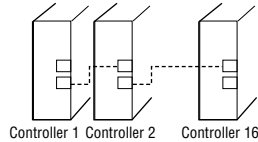

● **I/O Cable** — **EZS** **EZC** — P.67

This cable is used exclusively for connection between the **EZ limo** controller and the host controller. A half-pitch connector allowing one-touch connection to the controller is attached at one end of the flat cable.



● **Sensor Cable** — **EZS** **EZC** — P.67

Use this cable to connect each sensor used in the controller mode to the controller.



● **Sensor Set** — **EZS** **EZC** — P.68

These sensors can be used in the controller mode or driver mode. The sensor set comes with the necessary mounting hardware.



● **Dual Axis Mounting Bracket** — **EZS** — P.69

This dual axis mounting bracket allows easy installation of a pair of axes (**EZS6/EZS4** linear slides). Various types of brackets are available to support combinations of X-Y and X-Z axes.

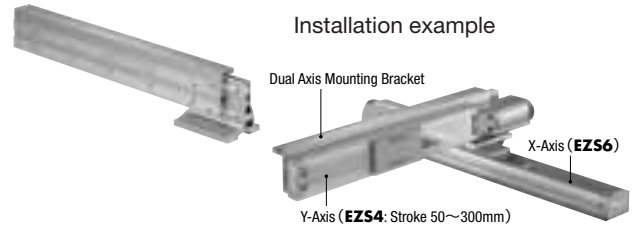

● **Cable Holder** — **EZS** — P.73

This low-noise cable holder protects and guides cables in multi-axis configurations. It can be easily installed on a dual axis mounting bracket using the supplied brackets.

Installation example



● **Cylinder Flange** — **EZC** — P.73

This special mounting bracket is used to install the cylinder from the body side. The flange comes with the mounting screws for affixing the cylinder to the flange. (The customer must provide the mounting screws for affixing the flange to the equipment.)



● **DIN Rail Mounting Plate** — **EZS** **EZC** — P.73

This plate is used to install the **EZ limo** controller to a DIN rail. The plate comes with the mounting screws.

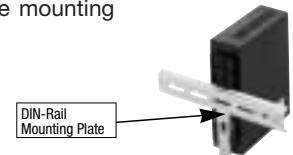

The following spare parts are also available:

● **Stainless Sheet (for linear slide)**  
— **EZS** — P.73

● **Battery (for absolute type)**  
— **EZS** **EZC** — P.73



\* Battery holder not supplied with a spare battery



## ■ EZHS Series • EZHC Series • EZHP Series

- Provided with the products
- Sold separately as optional parts

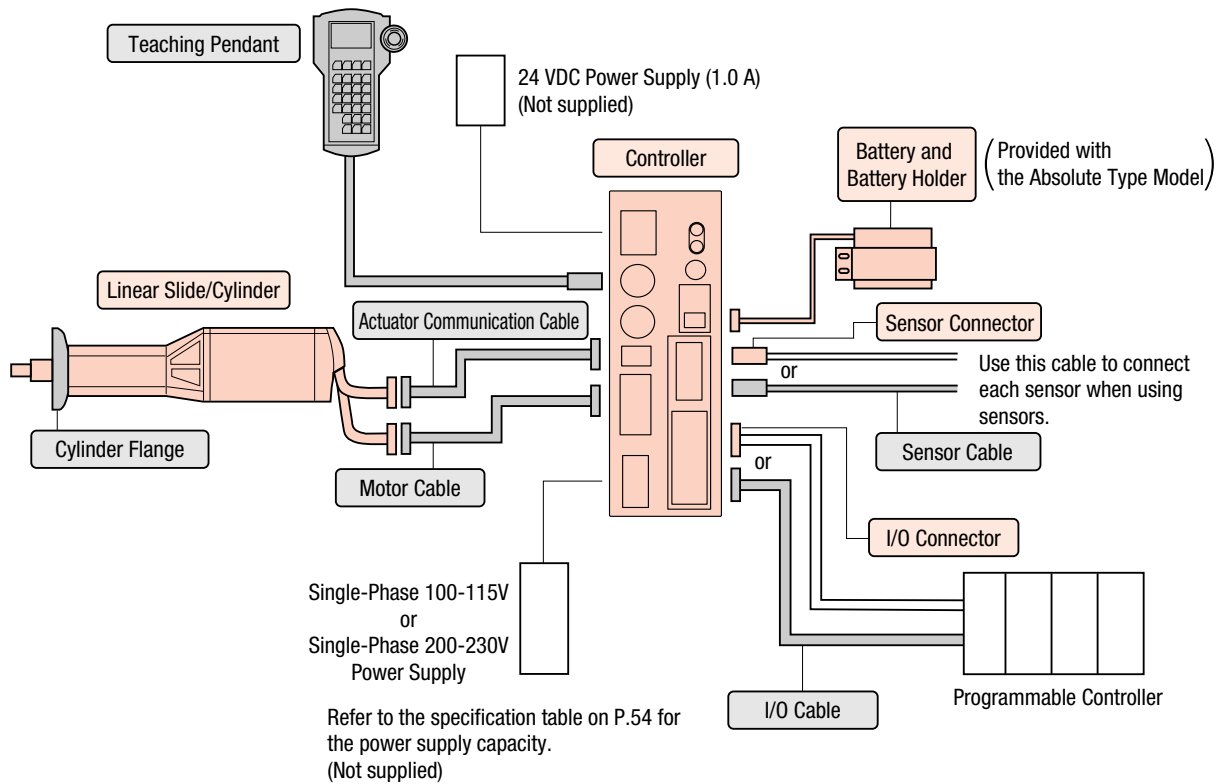

### ■ Optional Parts (sold separately)

- EZHS** For use with the **EZHS** series
- EZHC** For use with the **EZHC** series
- EZHP** For use with the **EZHP** series

### ● Teaching Pendant — **EZHS** **EZHC** **EZHP** — P.65

The teaching pendant allows you to set and execute motion profiles already stored, as well as to monitor the set data, current position and I/O status in real time.



### ● Cable Set — **EZHS** **EZHC** **EZHP** — P.66

A set of dedicated cables is used to connect the **EZ limo** linear slide/cylinder with the controller. The cable set consists of a motor cable and an actuator communication cable. The cable length can be selected from 2 m, 5 m and 10 m. Each of the cables can be purchased individually. Flexible cables are also available.



Motor cable



Actuator communication cable

● **Controller Link Cable** — **EZHS EZHC EZHP** — P.67

Use this dedicated cable to link the **EZ limo** controllers. A maximum of 16 controllers can be connected, with data set separately for each of the controllers.



● **I/O Cable** — **EZHS EZHC EZHP** — P.67

This cable is used exclusively for connection between the **EZ limo** controller and the host controller. A half-pitch connector allowing one-touch connection to the controller is attached at one end of the flat cable.

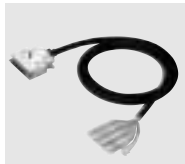

● **Sensor Cable** — **EZHS EZHC EZHP** — P.67

Use this cable to connect each sensor used in the controller mode to the controller.

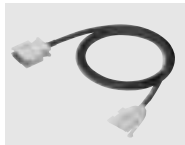

● **Sensor Set** — **EZHS EZHC EZHP** — P.68

These sensors can be used in the controller mode or driver mode. The sensor set comes with the necessary mounting hardware.

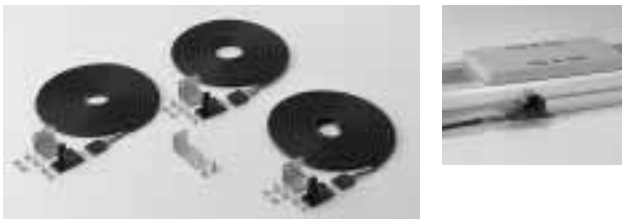

● **Dual Axis Mounting Bracket** — **EZHS** — P.69

This dual axis mounting bracket allows easy installation of a pair of axes (**EZHS6/EZHS4** linear slides). Various types of brackets are available to support combinations of X-Y and X-Z axes.

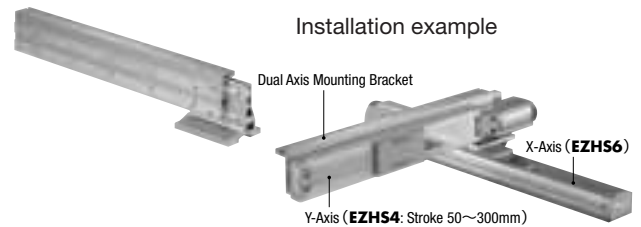

● **Cable Holder** — **EZHS** — P.73

This low-noise cable holder protects and guides cables in multi-axis configurations. It can be easily installed on a dual axis mounting bracket using the supplied brackets.

Installation example



● **Cylinder Flange** — **EZHC EZHP** — P.73

This special mounting bracket is used to install the cylinder from the body side. The flange comes with the mounting screws for affixing the cylinder to the flange. (The customer must provide the mounting screws for affixing the flange to the equipment.)



The following spare parts are also available:

● **Stainless Sheet (for linear slide)** — **EZHS** — P.73

● **Battery (for absolute type)** — **EZHS EZHC EZHP** — P.73

\* Battery holder not supplied with a spare battery

