

# Stepping Motors

## Structure of Stepping Motors

The figures below show two cross-sections of a 5-phase stepping motor. The stepping motor consists primarily of two parts: a stator and rotor. The rotor in turn is made up of three components: rotor cup 1, rotor cup 2 and a permanent magnet. The rotor is magnetized in the axial direction so that, for example, if rotor cup 1 is polarized north, rotor cup 2 will be polarized south.

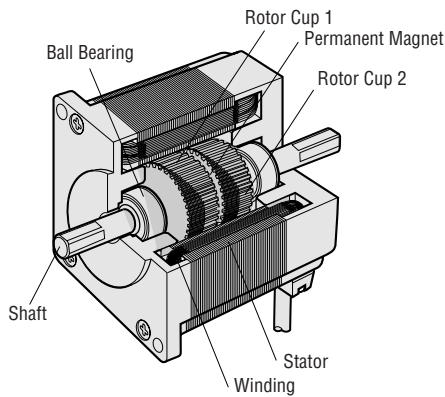

Motor Structural Diagram 1: Cross-Section Parallel to Shaft

The stator has 10 magnetic poles with small teeth, each pole being provided with a winding.

Each winding is connected to the winding of the opposite pole so that both poles are magnetized in the same polarity when current is sent through the pair of windings. (Running a current through a given winding magnetizes the opposing pair of poles in the same polarity, i.e., north or south.)

The opposing pair of poles constitutes one phase. Since there are five phases, A through E, the motor is called a “5-phase stepping motor.”

There are 50 teeth on the outer perimeter of each rotor, with the teeth of rotor cup 1 and rotor cup 2 being mechanically offset from each other by half a tooth pitch.

Excitation: To send current through a motor winding.

Magnetic pole: A projected part of the stator, magnetized by excitation.

Teeth: The teeth on the rotor and stator.

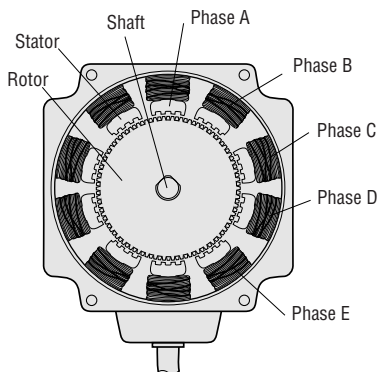

Motor Structural Diagram 2: Cross-Section Perpendicular to Shaft

## Principles of Operation

Following is an explanation of the relationship between the magnetized stator teeth and rotor teeth.

### When Phase “A” Is Excited

When phase A is excited, its poles are polarized south. This attracts the teeth of rotor cup 1, which are polarized north, while repelling the teeth of rotor cup 2, which are polarized south. Therefore, the forces on the entire unit in equilibrium hold the rotor stationary.

At this time, the teeth of the phase-B poles, which are not excited, are misaligned with the south-polarized teeth of rotor 2 so that they are offset  $0.72^\circ$ .

This summarizes the relationship between the stator teeth and rotor teeth with phase A excited.

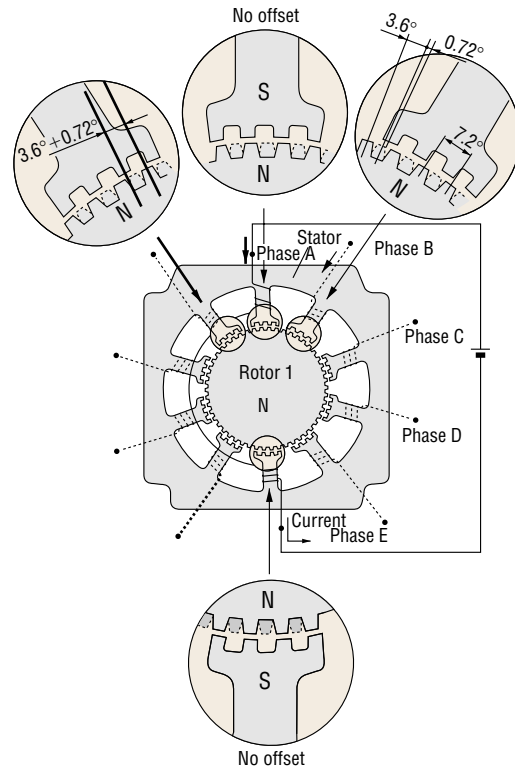

● **When Phase “B” Is Excited**

When excitation switches from phase A to B, the phase B poles are polarized north, attracting the south polarity of rotor 2 and repelling the north polarity of rotor cup 1.

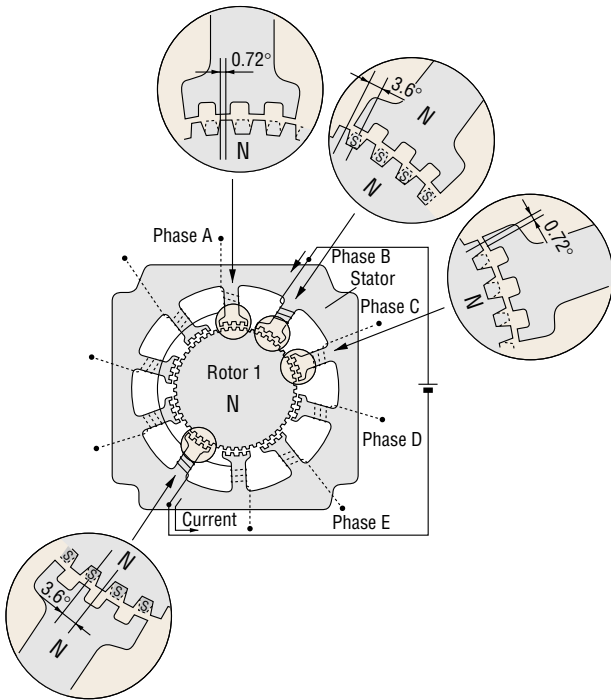

In other words, when excitation switches from phase A to B, the rotor rotates by 0.72°. As excitation shifts from phase A, to phases B, C, D and E, then back around to phase A, the stepping motor rotates precisely in 0.72° steps.

To rotate in reverse, reverse the excitation sequence to phase A, E, D, C, B, then back around to phase A. High resolution of 0.72° is inherent in the mechanical offset between the stator and rotor, accounting for the achievement of precise positioning without the use of an encoder or other sensors. High stopping accuracy of ±3 arc minutes (with no load) is obtained, since the only factors affecting stopping accuracy are variations in the machining precision of the stator and rotor, assembly precision and DC resistance of windings.

The driver performs the role of phase switching, and its timing is controlled by a pulse-signal input to the driver. The example above shows the excitation advancing one phase at a time, but in an actual stepping motor an effective use of the windings is made by exciting four or five phases simultaneously.

■ **αSTEP Stepping Motor**

● **Overview of the Control System**

◆ **Equipped with a proprietary rotor position sensor**

A rotor position sensor is built-in the rear end of the motor shaft.

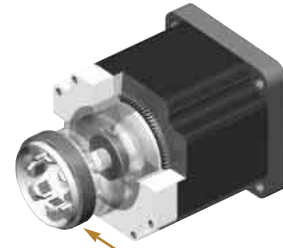

Sensor to detect rotor's position

The sensor winding detects changes in magnetic reluctance due to the angular position of the rotor.

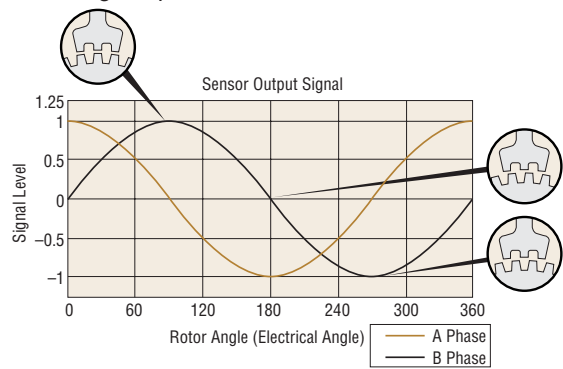

Output Signal of Rotor Position Sensor

◆ **Featuring Innovative Closed-Loop Control**

The deviation counter calculates the deviation (lag/advance) of the rotor's actual angular position with regard to the position command by the pulse train signal. The calculation result is used to detect a “misstep region” and operate the motor by switching between open and closed modes.

- If the positional deviation is less than ±1.8°, the motor will run in the open mode.
- If the positional deviation is ±1.8° or more, the motor will run in the closed mode.

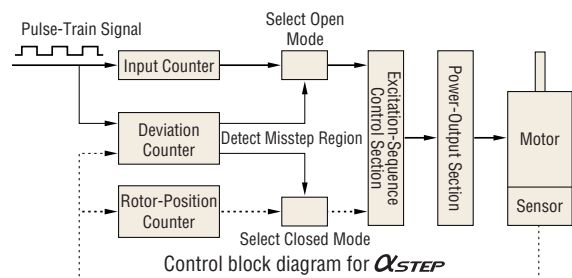

Rotor position counter: Specifies an excitation sequence that would develop maximum torque for a given rotor position.

In the closed loop mode, motor-winding excitation is controlled so that maximum torque is developed for the given angular position of the rotor. This control method eliminates unstable positions (misstep region) in the angle vs. torque characteristics.

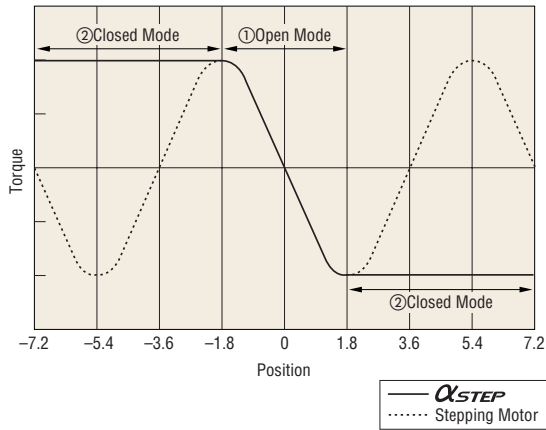

Angle vs. Torque Characteristics

● Features of **AlphaSTEP**

◆ Improved Stepping Motor Performance

- At high speeds **AlphaSTEP** will not “misstep.” Therefore, unlike conventional stepping motors, the **AlphaSTEP** operation will be free of the following restrictions:
  - Restrictions on acceleration/deceleration rates and inertia ratio stemming from the pulse profile of the controller.
  - Restrictions on starting-pulse speed causing “misstep.”
- Use the velocity filter to adjust responsiveness while starting/stopping

The responsiveness of starting/stopping can be adjusted with 16 settings without changing the controller data (starting pulse, acceleration/deceleration rates). This feature is intended to reduce shock to the work and vibration during low-speed operation.

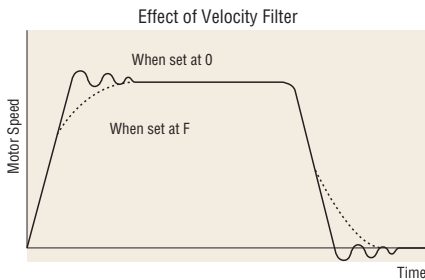

■ Basic Characteristics of Stepping Motors

An important point to consider in the application of stepping motors is whether the motor characteristics are suitable to the operating conditions. The following sections describe the characteristics to be considered in the application of stepping motors.

The two main characteristics of stepping motor performance are:

Dynamic Characteristics

These are the starting and rotational characteristics of a stepping motor, mainly affecting the unit’s movement and cycling time.

Static Characteristics

These are the characteristics relating to the changes in angle that take place when the stepping motor is in standstill mode, affecting the motor’s level of precision.

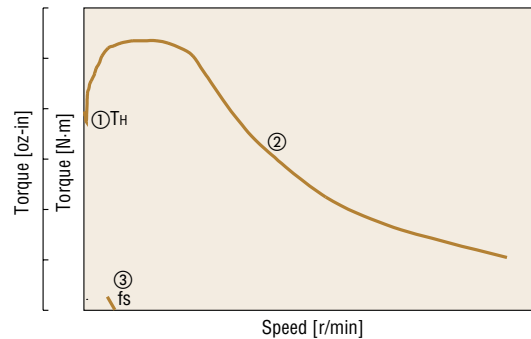

Speed vs. Torque Characteristics

● **Dynamic Characteristics**

◆ **Speed vs. Torque Characteristics**

Below is a characteristic curve showing the relationship between the speed and torque of a driven stepping motor. These characteristics are always referred to in the selection of a stepping motor.

The horizontal axis represents the motor's output-shaft speed, and the vertical axis represents the torque.

The speed vs. torque characteristics are determined by the motor and driver, and are greatly affected by the type of driver being used.

① **Holding Torque**

The holding torque is the stepping motor's maximum holding power (torque) when power is supplied (at rated current) when the motor is not rotating.

② **Pullout Torque**

The pullout torque is the maximum torque that can be output at a given speed.

When selecting a motor, be sure the required torque falls within this curve.

③ **Maximum Starting Frequency ( $f_s$ )**

This is the maximum pulse speed at which the motor can instantaneously start or stop (without an acceleration or deceleration period) when the stepping motor's frictional load and inertial load are 0. Driving the motor at a pulse speed in excess of this rate will require a gradual acceleration or deceleration. This frequency will decrease when a load inertia is added to the motor.

(Refer to the inertial load vs. maximum starting-frequency characteristics to the right.)

**Maximum Response Frequency ( $f_R$ )**

This is the maximum pulse speed at which the motor can be operated through gradual acceleration or deceleration when the stepping motor's frictional load and load inertia are 0.

The figure below shows the speed vs. torque characteristics of a 5-phase stepping motor and driver package.

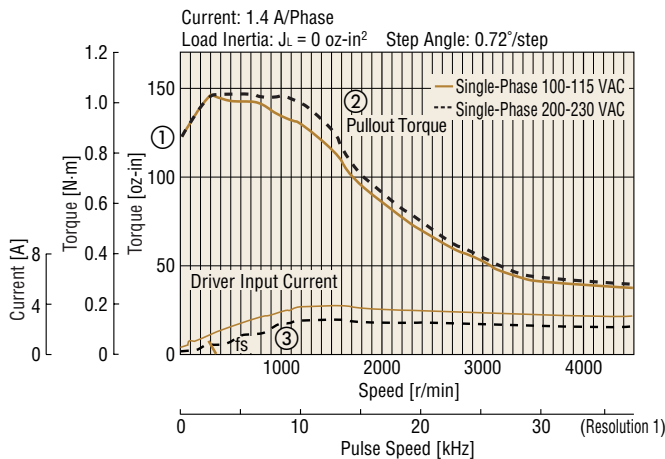

◆ **Load Inertia vs. Starting Frequency Characteristics**

These characteristics show the changes in the starting frequency caused by the load inertia. Since the stepping motor's rotor and load have their own inertia, lags and advances occur on the motor axis during instantaneous starting and stopping. These values change with the pulse speed, but the motor cannot follow the pulse speed beyond a certain point, so that missteps result. The pulse speed immediately before the occurrence of a misstep is called the starting frequency.

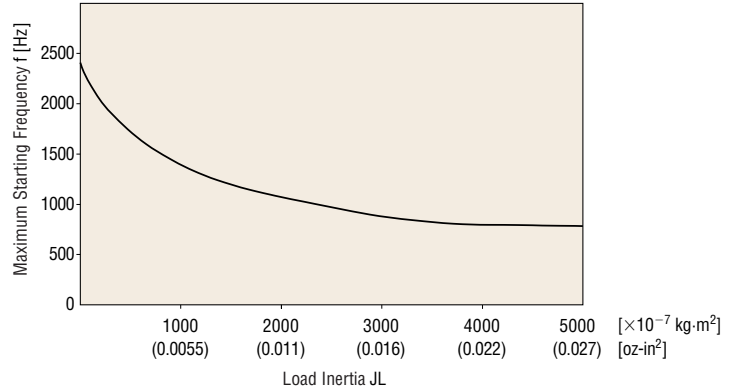

Load Inertia vs. Starting Frequency Characteristics

Changes in maximum starting frequency with the load inertia may be approximated via the following formula:

$$f = \frac{f_s}{\sqrt{1 + \frac{J_L}{J_0}}} \text{ [Hz]}$$

$f_s$ : Maximum starting frequency (Hz) of motor

$f$ : Maximum starting frequency (Hz) where load inertia is present

$J_0$ : Moment of inertia of rotor [oz-in<sup>2</sup> (kg·m<sup>2</sup>)]

$J_L$ : Moment of inertia of load [oz-in<sup>2</sup> (kg·m<sup>2</sup>)]

### ◆ Vibration Characteristics

The stepping motor rotates through a series of stepping movements. A stepping movement may be described as a single-step response, as shown below:

- ① A single pulse input to a stopped stepping motor accelerates the motor toward the next stop position.
- ② The accelerated motor rotates through the step angle, overshoots a certain angle, and is pulled back in reverse.
- ③ The motor settles to a stop at the set stop position following a damping oscillation.

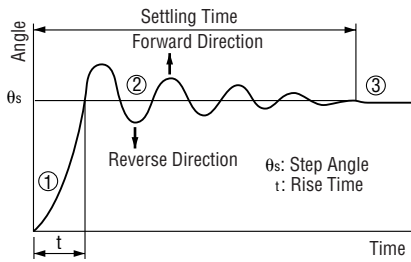

Single Step Response

Vibration at low speeds is caused by a step-like movement that produces this type of damped oscillation. The graph of vibration characteristics below represents the magnitude of vibration of a motor in operation. The lower the vibration level, the smoother the motor rotation will be.

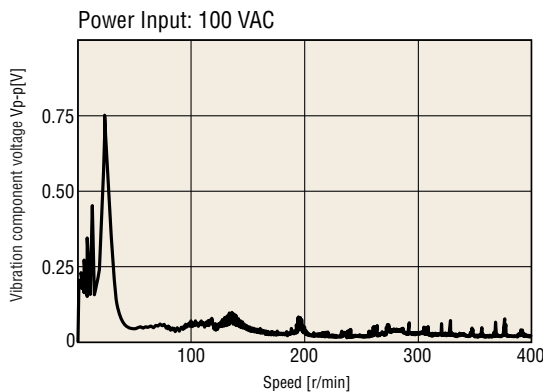

Vibration Characteristics

### ● Static Characteristics

#### ◆ Angle vs. Torque Characteristics

The angle vs. torque characteristics show the relationship between the angular displacement of the rotor and the torque externally applied to the motor shaft while the motor is energized at the rated current. The curve for this characteristic is shown below:

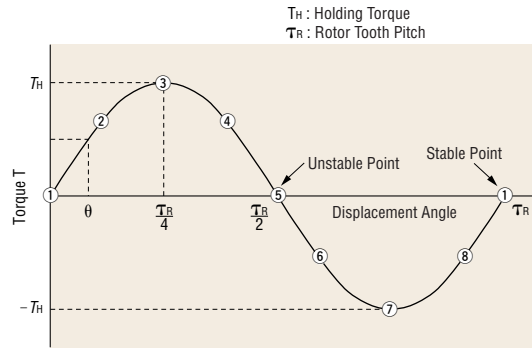

Angle vs. Torque Characteristics

The illustrations below show the positional relationship between the rotor teeth and stator teeth at the numbered points in the diagram above.

When held stable at point ① the external application of a force to the motor shaft will produce torque  $T(+)$  in the counterclockwise direction, trying to return the shaft to stable point ①. The shaft will stop when the external force equals this torque at point ②. If additional external force is applied, there is an angle at which the torque produced will reach its maximum at point ③. This torque is called the holding torque  $T_H$ .

Application of external force in excess of this value will drive the rotor to an unstable point ⑤ and beyond, producing torque  $T(-)$  in the same direction as the external force, so that it moves to the next stable point ① and stops.

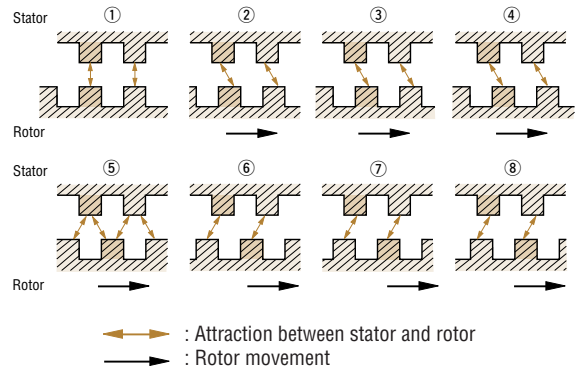

#### Stable points:

Points where the rotor stops, with the stator teeth and rotor teeth are exactly aligned. These points are extremely stable, and the rotor will always stop there if no external force is applied.

#### Unstable points:

Points where the stator teeth and rotor teeth are half a pitch out of alignment. A rotor at these points will move to the next stable point to the left or right, even under the slightest external force.

### ◆ Angular Accuracy

Under no-load conditions, a stepping motor has an angular accuracy within  $\pm 3$  arc minutes ( $0.05^\circ$ ). The small error arises from the difference in mechanical precision of the stator and rotor and a small variance in the DC resistance of the stator winding. Generally, the angular accuracy of the stepping motor is expressed in terms of the static angle error, as described below.

### ◆ Static Angle Error

The static angle error is the difference between the rotor's theoretical stopping position and its actual stopping position. A given rotor stopping point is taken as the starting point, then the static angle error is the difference between the maximum (+) value and maximum (-) value in the set of measurements taken for each step of a full rotation.

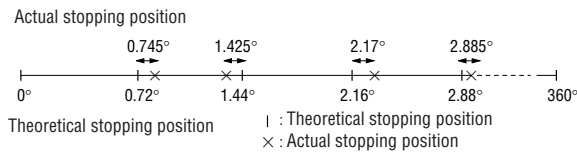

The static angle error is within  $\pm 3$  arc minutes ( $0.05^\circ$ ), but only under no-load conditions. In actual applications there is always some amount of frictional load. The angular accuracy in such cases is produced by the angular displacement caused by the angle vs. torque characteristics based upon the frictional load. If the frictional load is constant, the angle of displacement will be constant for rotation in one direction. However, when operating in both forward and reverse, double the displacement angle is produced over a round trip. When high stopping accuracy is required, always position from one direction only.

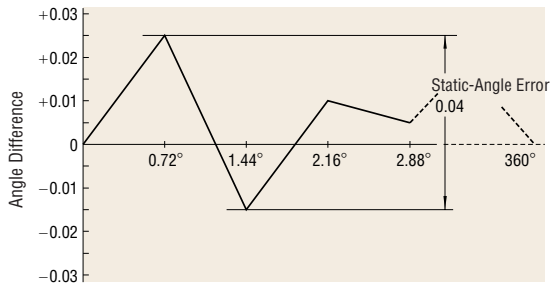

### ■ Stepping Motor Packages

Every 5-phase unit listed in our catalog consists of a New Pentagon, five-lead wire motor and a driver incorporating a special excitation sequence. This combination, which is proprietary to Oriental Motor, offers the following benefits:

- Simple connections for five leads
- Low vibration

The following sections describe the wiring and excitation sequence.

#### ● New Pentagon, 4-Phase Excitation: Full Step System ( $0.72^\circ/\text{step}$ )

This is a system unique to the 5-phase motor, in which four phases are excited. The stepping angle is  $0.72^\circ$  ( $0.36^\circ$ ). It offers a great damping effect, and therefore stable operation.

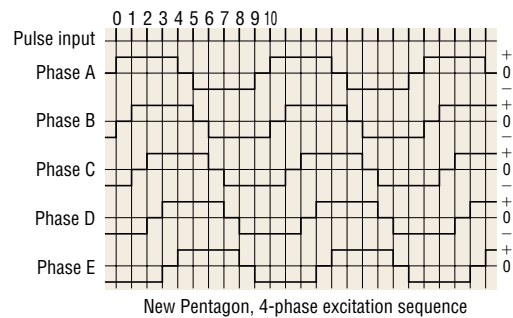
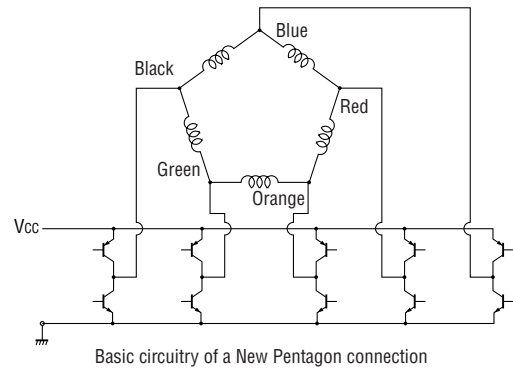

#### ● New Pentagon, 4-5-Phase Excitation: Half-Step ( $0.36^\circ/\text{step}$ )

A step sequence of alternating the four-phase and five-phase excitation produces rotation at  $0.36^\circ$  per step. One revolution may be divided into 1,000 steps.

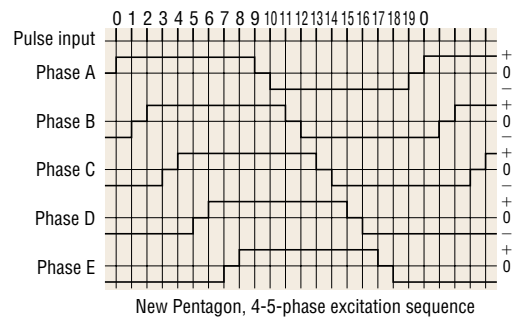

## Stepping Motor Drivers

There are two common ways of driving a stepping motor: constant current drive and constant voltage drive. The circuitry for the constant voltage drive is simpler, but it's relatively more difficult to achieve torque performance at high speeds. The constant current drive, on the other hand, is now the most commonly used drive method, since it offers excellent torque performance at high speeds. All Oriental Motor stepping motor and driver packages use the constant current drive system.

### An Introduction to Constant Current Drivers

The stepping motor rotates through the sequential switching of current flowing through the windings. When the speed increases, the switching rate also becomes faster and the current rise falls behind, resulting in lost torque. The chopping of a DC voltage that is far higher than the motor's rated voltage will ensure the rated current reaches the motor, even at higher speeds.

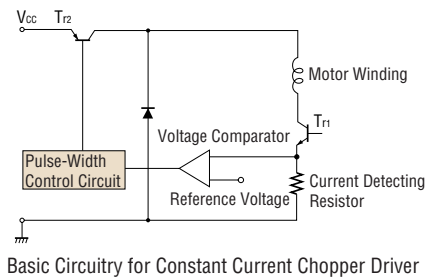

The current flowing to the motor windings, detected as a voltage through a current detecting resistor, is compared to the reference voltage. Current control is accomplished by holding the switching transistor  $Tr_2$  ON when the voltage across the detecting resistor is lower than the reference voltage (when it hasn't reached the rated current), or turning  $Tr_2$  OFF when the value is higher than the reference voltage (when it exceeds the rated current), thereby providing a constant flow of rated current.

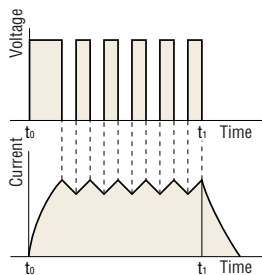

Voltage-current relationship in constant current chopper drive

### Differences Between AC Input and DC Input Characteristics

A stepping motor is driven by a DC voltage applied through a driver. In Oriental Motor's 24 VDC input drivers, 24 VDC is applied to the motor. In the 115 VAC and 220 VAC drivers the input is rectified to DC and then approximately 162 VDC is applied to the motor. (Certain products are exceptions to this.)

This difference in voltages applied to the motors appears as a difference in torque characteristics at high speeds. This is due to the fact that the higher the applied voltage is, the faster the current rise through the motor windings will be, facilitating the application of rated current at higher speeds. Thus, the AC input unit has superior torque characteristics over a wide speed range, from low to high speeds, offering a large speed ratio. It is recommended that AC input units, which are compatible with a wider range of operating conditions, be considered for your applications.

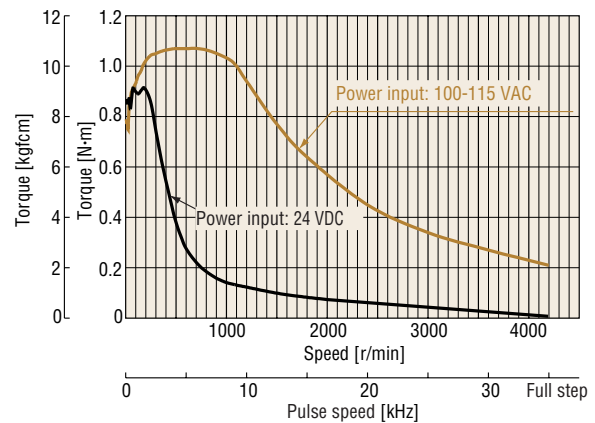

Comparison of the characteristics of AC input and DC input

### Microstep Drive Technology

Microstep drive technology is used to divide the basic step angle ( $0.72^\circ$ ) of the 5-phase stepping motor into smaller steps (up to a maximum of 1/250th) without the use of a speed reduction mechanism.

### Microstep Drive Technology

The stepping motor moves and stops in increments of the step angle determined by the rotor and stator's salient pole structure, easily achieving a high degree of precision in positioning. The stepping motor, on the other hand, causes the rotor speed to vary because the motor rotates in step angle increments, resulting in resonance or greater vibration at a given speed.

Microstepping is a technology that achieves low resonance, low noise operation at extremely low speeds by controlling the flow of electric current fed to the motor coil and thereby dividing the motor's basic step angle into smaller steps.

- The motor's basic step ( $0.72^\circ/\text{full step}$ ) can be divided into smaller steps ranging from 1/1 to 1/250. Microstepping thus ensures smooth operation.
- With the technology for smoothly varying the motor drive current, motor vibration can be minimized for low noise operation.

### ◆ Up to 250 Microsteps

Thanks to the microstep driver, different step angles (16 step resolutions up to 1/250) can be set to two step angle switches. By controlling the input signal for step angle switching via an external source, it is possible to switch the step angle between the levels set for the respective switches. The step angle can be switched at any given position, and switching will not cause the stop position to become misaligned.

### Features of Microstep Driving

#### ● Low Vibration

Microstep technology electronically divides the step angle into smaller steps, ensuring smooth incremental motion at low speeds and significantly reducing vibration. While a damper or similar device is generally used to reduce vibration, the low vibration design employed for the motor itself—along with the microstep technology—minimizes vibration more effectively. Anti-vibration measures can be dramatically simplified, so it's ideal for most vibration sensitive applications and equipment.

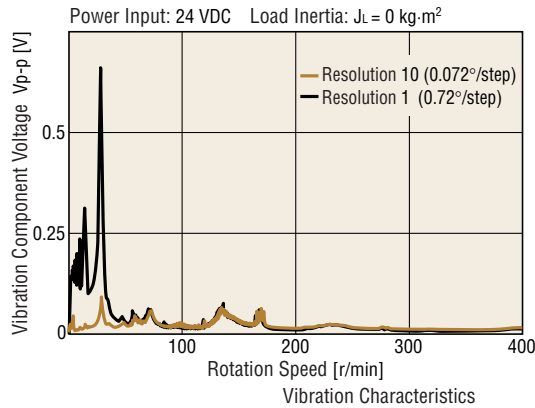

#### ● Low Noise

Microstep technology effectively reduces the vibration related noise level at low speeds, achieving low noise performance. The motor demonstrates outstanding performance in even the most noise sensitive environment.

#### ● Improved Controllability

- The New Pentagon microstep driver, with its superior damping performance, minimizes overshoot and undershoot in response to step changes, accurately following the pulse pattern and ensuring improved linearity.
- Shock normally resulting from the motions of starting and stopping can be lessened.

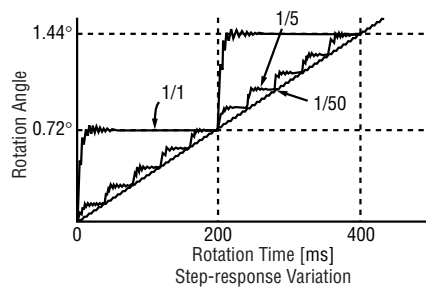

### ■ Relationship Between Cable Length and Transmission Frequency

A longer pulse line cable equates to a lower maximum frequency of transmission. Specifically, the resistive component and stray capacitance of the cable cause the formation of a CR circuit, thereby delaying the pulse rise and fall times.

Stray capacitance of the cable occurs between electrical wires and ground planes. However, it is difficult to provide distinct numerical data, because conditions vary according to the cable type, layout, routing and other factors.

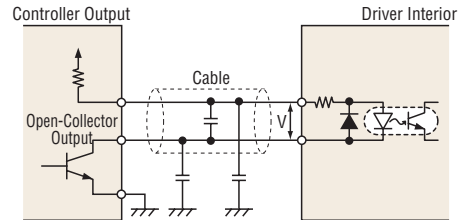
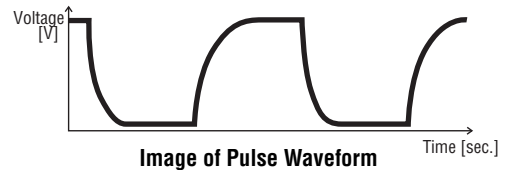

Image Diagram of Stray Capacitance in Cable



The following table shows the transmission frequencies (actual measurements provided for reference purposes) of the cables when used with Oriental Motor products.

Maximum transmission frequencies (reference data)

Driver	Controller	Cable	Maximum transmission frequency
RK Series	EMP400 Series	CC01EMP5 (1 m)	170 kHz
		CC02EMP5 (2 m)	140 kHz
AS Series		CC01EMP4 (1 m)	150 kHz
CC02EMP4 (2 m)		120 kHz	



## ■ Glossary

### ● 1-Step Response

The stepping motor rotates through a series of stepping movements. 1-step response refers to the step-like movement (the movement of one step and stop).

### ● CW, CCW

The direction of motor rotation is expressed as CW (clockwise) or CCW (counterclockwise). These directions are as seen from the output shaft.

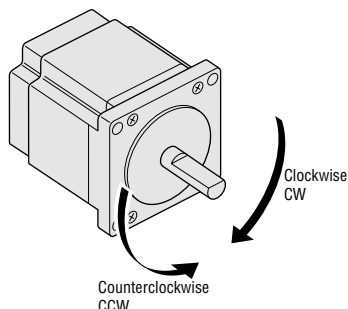

### ● T.I.R.

Total Indicator Reading: Refers to the total dial gauge reading when the measurement section is rotated one revolution centered on the reference axis center.

### ● Overhung Load

The load on the motor shaft in the vertical direction. The value varies with the model.

### ● Regeneration

This is the condition in which the motor is being rotated by an external force, or the generation of electric power through such rotation.

### ● Angle Accuracy

The difference between the actual rotation angle and the theoretical rotation angle. Although there are several expressions according to how the criteria are set, generally, the angular accuracy of the stepping motor is expressed in terms of the static angle error.

### ● Angular Transmission Error

Angular transmission error is the difference between the theoretical angle of rotation of the output shaft, as calculated from the input pulse count, and the actual angle of rotation. It is generally observed when a speed reduction mechanism is provided. Angular transmission error is used to represent the accuracy of a speed reduction mechanism. Oriental Motor's Planetary (**PN**) gear is designed to minimize the angular transmission error to a maximum of only six arc-minutes, and may be effectively used in high-precision positioning and indexing applications.

### ● Inertial Load (Moment of Load Inertia)

This is the degree of force possessed by a physical object to maintain its current level of kinetic energy. Every physical object has an inherent inertial load. Greater torque is required to accelerate and decelerate an object having a larger inertial load. The degree of such torque is proportional to the degree of inertial load and the acceleration rate that is obtained from the operating speed and acceleration time.

### ● Automatic Current Cutback Function

This is a function used for the automatic reduction of motor current by approximately 50 percent (approximately 40 percent in the **CSK** and **UMK** Series 2-phase motors) when the pulse signal is not input. This minimizes the heating of the motor and driver.

This function automatically reduces the motor current at motor standstill, and does so within approximately 0.1 second after the pulse signal stops.

Holding torque [oz-in (N·m)] =

$$\frac{\text{Maximum static torque at excitation [oz-in (N·m)]} \times \text{Current at motor standstill [A]}}{\text{Rated motor current [A]}}$$

### ● Resonance

This refers to the phenomenon in which vibration becomes larger at specific speeds. For 2-phase stepping motors, the area between 100-200 Hz is a resonance area; 5-phase stepping motors have lower levels of resonance in their resonance area.

### ● Vibration Component Voltage

Vibration component voltage is the level of deviation from the reference rotation speed.

### ● Vibration Characteristics

A graph with the horizontal axis expressing the speed and the vertical axis expressing the vibration component voltage.

### ● Thrust Load

The thrust load is the load in the direction of the motor axis. The value varies with the model.

● **Static Angle Error**

This refers to the difference between the rotor's theoretical stopping position and its actual stopping position. A given rotor stopping point is taken as the starting point, then the static angle error is the difference between the maximum (+) value and maximum (-) value in the set of measurements taken for each step of a full rotation. The static angle error is within  $\pm 3$  arc minutes ( $0.05^\circ$ ), but only under no-load conditions. The small error arises from the difference in mechanical precision of the stator and rotor and a small variance in the resistance of the stator winding. However, in actual applications there is always frictional load. The angular accuracy in such cases is produced by the angular displacement caused by the angle vs. torque characteristics based upon the frictional load.

● **Loss of Synchronism**

Stepping motors are synchronized by pulses. They can lose their synchronization when speed changes rapidly or an overload occurs. Loss of synchronism is the term for losing synchronization with the input pulse. The correctly selected and normally operated motor doesn't suffer a sudden loss of synchronism.

● **Twisted Pair Wires**

Twisted pair wires entwine two wires as shown in the figure below. They are used to reduce noise in signal wires. Because the wires face in opposite directions from each other and carry the same current, noise from the ambient surroundings is cancelled out and noise effects reduced.

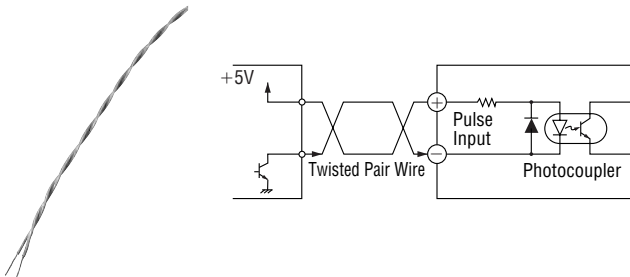

● **Electromagnetic Brake**

The mechanical brake that is used to hold the motor in place. Oriental Motor uses a non-excitation type of electromagnetic brake that automatically holds the motor in place in the event of a power failure or other interruption.

● **Backlash**

The play in the gear output shaft when the motor shaft is fixed. It affects positioning precision when positioning occurs from both directions. The term originally referred to looseness between gear teeth.

● **Pulse Input Mode**

The pulse mode used when the CW/CCW rotation direction is controlled by the pulse command. The pulse input configuration may be 1-pulse (1P) input mode or 2-pulse (2P) input mode. The 1-pulse input mode uses the pulse signal and rotational direction signal, while the 2-pulse input mode uses the CW pulse input for the CW direction and the CCW pulse input for the CCW direction.

● **Photocoupler “ON” “OFF”**

Photocouplers are electronic components that relay electrical signals as light. They are electronically insulated on the input and output sides, so noise has little effect on them. Input (Output) “ON” means that the photocoupler inside the driver is energized, and Input (Output) “OFF” means that the photocoupler inside the driver is not energized.

Photocoupler state    OFF    ON

● **Microstepping**

Microstepping is a technology used to achieve greater resolution by controlling the flow of current to the motor's coil and dividing the step angle into smaller steps. Extremely small steps help eliminate vibrations caused by the stepping drive, thus achieving low vibration, low noise operation.

● **Excitation Home Position**

Condition in which the excitation sequence is in its initial condition. In the 5-phase stepping motor, the sequence returns to the initial condition at  $7.2^\circ$  intervals.

● **Excitation Sequence**

The stepping motor rotates by sending current to the motor coils according to a preset combination and order. The excitation sequence is the order in which current is sent to the motor coils. It varies with the type of motor and excitation system.

● **Excitation Timing Output**

This is a signal that indicates that the excitation sequence is initialized, which is a function of the driver. It is output every  $7.2^\circ$ . For 5-phase stepping motors, it is output every 10 pulses (for full step) or 20 pulses (for half step).